



**INTERNATIONAL RULES**  
**FOR**  
**UNDERWATER HOCKEY**

**8th Edition**  
**Version 8.20**  
**January, 2004**

*William (Woody) Lee*

## INDEX

### **0. DESCRIPTION AND DEFINITIONS.**

- .1 Description
- .2 Definitions

### **1. PLAYING AREA AND EQUIPMENT.**

- .1 Playing Area
- .2 Goals
- .3 The Puck
- .4 The Stick

### **2. TEAM COMPOSITION, PERSONAL EQUIPMENT, AND IDENTIFICATION.**

- .1 Team Composition
- .2 Personal Equipment
- .3 Team Identification

### **3. OFFICIALS AND THEIR EQUIPMENT.**

- .1 Number, Titles, and Qualifications
- .2 Chief Referee's Duties
- .3 Water Referee's Duties
- .4 Time-Keeper/Scorer's Duties
- .5 Officials' Equipment
- .6 Signals

### **4. THE GAME.**

- .1 Rules of Play
- .2 Duration of Play
- .3 Starting Play
- .4 Substitution
- .5 Stopping Play
- .6 Scoring Procedure

### **5. FOUL PLAY.**

- .1 Advantage Rule
- .2 Corner Rule
- .3 Infringements

### **6. PENALTIES.**

- .1 Action by Officials
- .2 Cautioning
- .3 Time Penalty
- .4 Total Dismissal
- .5 Equal Puck
- .6 Advantage Puck
- .7 Infringement Assessment
- .8 Penalty Shot

- .9 Penalty Goal
- .10 Side-Line-Out or Puck Out-of-Bounds
- .11 Incorrect Starts
- .12 Obstruction

## **7. GENERAL.**

- .1 Pre-Match Preparations
- .2 Protests and Appeals
- .3 Match Abandonment
- .4 Ruling Body

## **8. AMENDMENT OF RULES.**

## **9. GUIDANCE NOTES.**

- .1 Definitive Text
- .2 Tournament Play Schedule
- .3 Rules Directors by Federation and Other Officials
- .4 Members of the Underwater Hockey Commission
- .5 Calgary 2002 Rules Meeting Participants

## **10. APPENDICES.**

- “A” Playing Area Dimensions
- “B” Playing Area Layout, Deck Side-Substitution
- “C” Playing Area Layout, In-Water Side-Substitution
- “D” Playing Area Layout, End-Line Substitution
- “E” Playing Area Markings
- “F” The Goals
- “G” The Puck
- “H” The Stick
- “I” Scoring Assessment: Successful
- “J” Scoring Assessment: Not Successful
- “K” Equal Puck
- “L” Advantage Puck
- “M” Penalty Shot
- “N” Signals
- “O” Multilevel Tournament With Eight Entries

## 0. DESCRIPTION AND DEFINITIONS.

### 0.1 Description

0.1.1 Underwater Hockey is a sport played on the bottom of a swimming pool by two teams of six players, each wearing basic snorkelling equipment, i.e. fins, mask, and snorkel. The object of the match is to push or pass a lead puck along the bottom of the pool, by using an underwater hockey stick, into the opposing team's goal.

### 0.2 Definitions

- 0.2.1 A **TOURNAMENT** is a series of competitive matches between two (2) or more teams at any one given time.
- 0.2.2 A **WORLD CHAMPIONSHIP** is a tournament between Federations involving one or more of the following:
- 0.2.2.1 A minimum of five (5) Federation **Mens** teams. *and/or*
  - 0.2.2.2 A minimum of three (3) Federation **Womens** teams. *and/or*
  - 0.2.2.3 A minimum of three (3) Federation **Open Masters** teams aged 35 years or more. An Open Master must have attained his/her 35th birthday on or before the first match of the competition. Open Masters teams may be mixed gender in any combination. *and/or*
  - 0.2.2.4 A minimum of three (3) Federation **Women Masters** teams aged 32 years or more. A Woman Master must have attained her 32<sup>nd</sup> birthday on or before the first match of the competition. *and/or*
  - 0.2.2.5 A minimum of three (3) Federation **Open Junior** teams aged 18 years or younger. An Open Junior must NOT have attained his/her 19th birthday on or before the first match of the competition. Open Junior teams may be mixed gender in any combination. *and/or*
  - 0.2.2.6 A minimum of three (3) Federation **Open Junior Women** teams aged 18 years or younger. An Open Junior Woman may NOT have attained her 19th birthday on or before the first match of the competition. *and/or*
  - 0.2.2.7 A minimum of three (3) Federation **Open Youth** teams aged 14 years and younger. An Open Youth may NOT have attained his/her 15th birthday on or before the first match of the competition. Open Youth teams may be mixed gender in any combination.
- 0.2.3 A **CONTINENTAL** or **ZONE TOURNAMENT** is a tournament between Federations of the same continent or zone.
- 0.2.4 The International Referee in control of the overall refereeing at a World Championship shall be the **WORLD TOURNAMENT REFEREE**.
- 0.2.5 Responsibilities of the hosting Federation
- 0.2.5.1 As soon as possible after CMAS gives approval for the World Championships to be held, and no later than a year prior to the event, the hosting Federation must provide details of the date, location, name, and specifications of the pool(s) to be used, accommodation facilities, and any specific information pertaining to how the matches are to be conducted (e.g. puck, goal frames, etc.)

## **1. PLAYING AREA AND EQUIPMENT.**

### **1.1 Playing Area** (See Appendix “A”, “B”, “C”, “D”, & “E”)

- 1.1.1 The playing area shall be a swimming pool or part thereof.
- 1.1.2 The playing area shall be 12m-15m wide and 21m-25m long, provided that the minimum playing area is 300 square metres.
- 1.1.3 The pool bottom must be flat or gently sloping, with a maximum gradient of 1 to 20.
- 1.1.4 The depth of the water shall be between 2m and 3.65m, with a  $\pm 10\%$  allowance with the approval of the World Tournament Director. Pools shallower than 2m must be considered “fast and safe” by the World Tournament Director.
- 1.1.5 The end-lines must be of a solid nature, i.e. pool walls.
- 1.1.6 A side-line may be either a pool wall, sturdy barrier, or a demarcation line on the pool bottom.
  - 1.1.6.1 The barrier should have a minimum height of 300mm.
  - 1.1.6.2 For World Championships, sturdy barriers or walls are essential. For Zone Championships or other tournaments, a sturdy barrier or wall is preferred. However, if not possible, a demarcation line is acceptable.
  - 1.1.6.3 The demarcation line belongs to the playing area.
- 1.1.7 At each end of a playing area, centred on the mid-point of the end line, a penalty shot area will be marked by a dotted line on the pool bottom to define a semi-circle with a 6m radius, and a goal area will be marked by a solid line on the pool bottom to define a semi-circle with a 3m radius.
- 1.1.8 A 1m arc will be placed in each of the four corners of the playing area to define the area of the corner rule.

### **1.2 Goals** (See Appendix “F”)

- 1.2.1 Shall be made of galvanised or stainless steel (of 2mm minimum thickness sheet metal) or similar frames, with all sharp edges removed and/or protected.
- 1.2.2 Open-ended goals will be used.
- 1.2.3 Shall be 3m long, placed in the centre of each end-line, and secured in position.
- 1.2.4 The area behind the anterior lip of the goal is called the trough.
- 1.2.5 The goal back is to have two (2) vertical lines marking the 3m limits of the goal volume.

### **1.3 The Puck** (See Appendix “G”)

- 1.3.1 The puck shall have a diameter of 80mm,  $\pm 4$ mm; and a thickness of 30mm, +4mm, -2mm. These are outside dimensions, which include the puck and any protective covering.
- 1.3.2 The radius of the puck edge, whether covered or not, shall be from 3mm to 10mm in radius.
- 1.3.3 The puck shall weigh 1.3kg,  $\pm 0.2$ kg.

### **1.4 The Stick** (See Appendix “H”)

- 1.4.1 The stick shall be made of wood, plywood, or a homogeneous material that floats horizontally in the water.
- 1.4.2 The stick must fit wholly in a box with the interior dimensions of 100mm x 350mm x 50mm.
  - 1.4.2.1 Minimum corner radius around the perimeter edge of the entire stick is 10mm.
  - 1.4.2.2 Edges where surfaces intersect must be rounded.
- 1.4.3 The stick must be uniformly black or white, but may have a discreet and simple symbol or initial(s) in a contrasting colour for identification purposes. If the Chief Referee or Water Referee determines that the symbol or initial(s) creates confusion as to the colour of the stick, the stick may be removed from play for that game.
- 1.4.4 The stick may not protrude from the heel of the protected hand by more than 25mm.

- 1.4.4.1 The puck may not be played with the portion of the stick that may protrude from the heel of the protected hand.
- 1.4.4.2 The “playing area” of the stick is that area not covered by the protected hand and forward of the thumb.
- 1.4.5 A wrist lanyard may attach the stick to the playing hand.
- 1.4.6 A player may tape the stick to the playing hand.
- 1.4.7 The stick may be of any shape or design within the minimum and maximum dimensions given. The illustration is only a guide (Appendix H). Knob(s) on the stick is/are allowed.
- 1.4.8 The stick must not be capable of surrounding the puck or any part of hand, nor encapsulating the puck by more than 50%, or locking the puck to the stick.

## **2. TEAM COMPOSITION, IDENTIFICATION, AND PERSONAL EQUIPMENT.**

### **2.1 Team Composition**

- 2.1.1 For an international tournament, a Federation may bring a squad up to twelve (12) players in each division, designated on the day preceding the first match of the tournament. From this number, a team of up to ten (10) members must be declared for any one match within the tournament. These team members are divided into a maximum of six (6) players and (4) substitutes who may be used at any time. The players from the squad not chosen for a particular match are the “reserves”.
  - 2.1.1.1 In the case of player coaches, the team may play with less than ten (10) players if the coach decides not to play for the entire match. The Chief Referee must be informed.
- 2.1.2 In the event of an accident or injury to a player resulting in a stoppage of play and assistance of the injured player to the poolside, the appropriate Team Captain must request and obtain the verbal approval of the Chief Referee to use a substitute.
  - 2.1.2.1 In the event of an injury, a reserve may not be used for that match.
- 2.1.3 A player who leaves the playing area and/or deck area due to an injury, having received treatment, may return to the match at the Chief Referee’s discretion.
- 2.1.4 In the event of injury or illness which is confirmed by a medical certificate, squad member(s) may be replaced for the duration of the tournament.
- 2.1.5 During play, the team is allowed up to three (3) people to help them in the match area. One may be in the water on the side-lines and the other two in the team substitution area. If the team decides not to have a person in the water, they can use only two (2) people in the team substitution area.

### **2.2 Personal Equipment**

- 2.2.1 Each player shall be equipped with a mask, which must have safety glass or other safety material fitted; a non-metal, pliable snorkel; a pair of conventional underwater hockey fins (made of rubber or other non-dangerous pliable synthetic material, excluding fibreglass) which is approved by the CMAS Underwater Hockey Commission; hand protection for the playing hand(s), and an underwater hockey stick (See Appendix “H”).
  - 2.2.1.1 The mask must be a dual lens mask unless it has a centre divider/support that is part of the frame of the mask.
  - 2.2.1.2 Hand protection must not contain rigid or sharp reinforcing material.
  - 2.2.1.3 Gloves used for hand protection may not have webbing between fingers, or be of any design which would aid in swimming.
  - 2.2.1.4 Head caps with firm polyethylene or rubber ear protectors must be worn.

- 2.2.2 Protective knee and/or elbow pad(s) may also be worn if required, provided they are constructed of soft materials.
- 2.2.3 Wet suits and/or weight belts may not be worn.
- 2.2.4 All personal and team equipment must have the prior approval a Water Referee.

### **2.3 Team Identification**

- 2.3.1 All players of each team shall wear identical bathing suits with respect to design and colour(s), which shall be of a light shade whenever the team is using white sticks or of a dark shade whenever the team is using black sticks.
- 2.3.2 All ten (10) players of each team shall wear identification caps, either black (or dark blue) or white, to match the colour of the sticks the team is using. The caps must have a unique numbers for each player of the squad.
- 2.3.3 Players are required to mark their cap number on both upper arms to assist in player identification during play. Numbers must have a minimum height of 7.5mm (~3 inches) and be of a contrasting colour to that of the skin.

## **3. OFFICIALS AND THEIR EQUIPMENT.**

### **3.1 Number, Titles, and Qualifications**

- 3.1.1 The Officials who shall control an International Underwater Hockey Match are: one Chief Referee, two Water Referees, Timekeeper(s)/Scorer(s), and other Officials as appointed by the Chief Referee.
- 3.1.2 The Chief Referee and two Water Referees shall be qualified International Referees, appointed by the Federation underwater authority and registered with the CMAS Underwater Hockey Commission.
- 3.1.3 Timekeeper(s)/Score(s) shall be qualified Federation referees.

### **3.2 Chief Referee's Duties**

- 3.2.1 The Chief Referee's duties are conducted from a position on the pool-side where an uninterrupted view of the playing area can be obtained.
- 3.2.2 The Chief Referee is responsible for:
  - 3.2.2.1 All aspects and the overall conduct of the match.
  - 3.2.2.2 Instructing the opposing teams of any special requirements of the match.
  - 3.2.2.3 Signalling the starting and stopping of play in accordance with rules 4.3 and 4.5.
  - 3.2.2.4 Observing any rule infringement which might only be visible from above the water, and to award appropriate penalties to offenders.
  - 3.2.2.5 Stopping and re-starting play as a result of time suspensions or time-outs.
  - 3.2.2.6 Determining that substitutions are done correctly.
  - 3.2.2.7 Authorising penalised players to re-enter water when advised by the Timekeeper(s)/Scorer(s).
    - 3.2.2.7.1 If the completion of the timed penalty occurs while play is stopped, apply rule 6.3.1.2.3.

### **3.3 Water Referee's Duties**

- 3.3.1 Water Referees conduct their duties from the water, and each shall generally be in charge of one longitudinal half of the playing area.
- 3.3.2 They are jointly responsible for:
  - 3.3.2.1 Inspecting all players' personal and team's equipment prior to the match.
  - 3.3.2.2 Enforcing the rules at all times.

- 3.3.2.3 Signalling the Chief Referee to stop play when a goal is scored.
- 3.3.2.4 Signalling the Chief Referee to stop play should any infringements occur.
- 3.3.2.5 Awarding appropriate penalties for rule infringements.
- 3.3.2.6 Ensuring the puck is placed in the correct position, and indicating the match is ready to be re-started to the Chief Referee.
- 3.3.2.7 Ensuring that the goal frames are aligned in their correct position at all times.
- 3.3.2.8 Signalling the Chief Referee to stop the match by showing the 'stop play' signal should an accident or injury occur, and immediately assist the injured player to the poolside.

### **3.4 Time-Keeper's/Scorer's Duties**

- 3.4.1 The duties of the Timekeeper/Scorer can be performed by one or more persons and shall be carried out from a position adjacent to the Chief Referee.
- 3.4.2 The responsibilities of the Timekeeper(s)/Scorer(s) are:
  - 3.4.2.1 Timing all play and indicating the completion of each time period to the Chief Referee.
  - 3.4.2.2 Timing players sent out of the water for two (2) or five (5) minute time penalties, and indicating to the Chief Referee when they may re-enter the water.
  - 3.4.2.3 Stopping the timing of the time period at the request of the Chief Referee in the event of a serious injury, the need to confer with the other Referees, or other special circumstances.
  - 3.4.2.4 Ensuring all goals are displayed and announced immediately after they have been scored.
  - 3.4.2.5 Keeping a written record of the goals scored, the player and team credited with the goals, and other information pertaining to the match which is deemed necessary to be recorded.
  - 3.4.2.6 Announcing the final score at the end of the match, once the details of the match have been verified and countersigned by the Referees.

### **3.5 Officials' Equipment**

- 3.5.1 The Chief Referee shall be equipped with a means of creating an audible signal above and below the surface of the water.
- 3.5.2 The Water Referee shall be equipped with: mask, which must have safety glass or other safety material fitted; a non-metal, pliable snorkel; a pair of conventional underwater hockey fins (made of rubber or other non-dangerous, pliable synthetic material, excluding fibreglass) which is approved by the CMAS Underwater Hockey Commission. The Water Referee shall also wear a clearly distinguishable shirt, red cap with ear protectors, and a pair of brightly coloured gloves.
  - 3.5.2.1 The mask must be a dual lens mask unless it has a centre divider/support that is part of the frame of the mask.
- 3.5.3 The Time-Keeper(s) shall be equipped with suitable timing facilities, sufficient to time both the match and at least two players sent out of the water for a time penalty.
- 3.5.4 The Scorer(s) shall be equipped with suitable means of keeping a written record of the match and a scoreboard which is visible from all parts of the playing area.

### **3.6 Signals**

(See Appendix "N")

- 3.6.1 **Ready to Start**  
The ready to start signal is one arm raised straight up in the air with signal hand open, fingers together.
- 3.6.2 **Stop Play**  
The stop play signal is one arm extended up in the air with the signal hand open, giving a wide rapid waving motion side-to-side.

- 3.6.3 **Time**  
The end of a timed match period is signalled by one hand on top of the other to form the letter “T”.
- 3.6.4 **Equal Puck**  
Equal puck is signalled by the arms being crossed above the head with hands clenched into fists.
- 3.6.5 **Advantage Puck**  
An advantage puck is signalled by backing up the infringing team, using an extended arm with the palm towards the offenders. Then use the free arm moving in a 90° arc over the water surface to indicate the infringing team line. Once the infringing team is positioned correctly, the backing-up arm is raised vertically with open hand. When both Referees have raised their backing-up arm, play can be re-started by the Chief Referee.
- 3.6.6 **Time Penalty**  
A time penalty is signalled by pointing with one arm to the infringing player, then to the penalty box with the same arm while indicating the penalty time with the fingers of the other hand held over the head.
- 3.6.7 **Total Dismissal**  
A total dismissal is signalled by pointing to the dismissed player, while swinging the other arm back and forth horizontally to the water in a 90° arc, then pointing to the penalty area.
- 3.6.8 **Goal**  
The signal for a goal is both arms raised straight up into the air with open hands.
- 3.6.9 **No Goal, or Goal Successfully Defended (Penalty Shot)**  
Signal is both elbows extended to the side from shoulders, forearms and hands straight, perpendicular to the water surface, fingers together and palms facing away from chest. Both forearms make arcs simultaneously toward the water surface, right arm arcing left, left arm arcing right. Repeat several times.
- 3.6.10 **Penalty Shot**  
A penalty shot is signalled by first giving the signal for stop play, and then vertically pumping one arm up and down from the shoulder with a clenched fist.
- 3.6.11 **Penalty Goal**  
A penalty goal is awarded by signalling the following sequence: stop play, then signalling a penalty shot, and finally a goal.
- 3.6.12 **Time-Out**  
Time-out is signalled by raising both arms above the head to form a large letter “O”, then pointing to the end-line of the team to be charged with the time-out.
- 3.6.13 **Illegal Use of Free Arm**  
Illegal use of free arm is signalled by one arm parallel to the water, bent at the elbow with fist clenched: the arm moves in a horizontal pumping motion.
- 3.6.14 **Obstruction, Barging, Blocking, or Shepherding**  
General blocking fouls are signalled by the two arms above the water being clasped at the wrists and moving the joined arms in and out from the chest.
- 3.6.15 **Advancing the Puck with the Free Hand, or Stick Infringements**  
These fouls are signalled by one fist punching into the palm of the other hand.
- 3.6.16 **Illegally Stopping the Puck**  
The signal for illegally stopping the puck is an open hand held in a vertical plane and moving up and down in a chopping action.
- 3.6.17 **Call by the Referee**  
The Referee may call anyone in the water by using one hand, palm facing the Referee, moving the fingers backwards and forwards in a beckoning or calling motion.

- 3.6.18 **Time Suspension (Official's Time-Out)**  
Referees may signal a time suspension by forming a large letter "O" over the head, then bringing the hands to the shoulder level and patting shoulders.
- 3.6.19 **Illegal Substitution**  
An official will signal an illegal substitution by a hand over hand rolling motion.
- 3.6.20 **Unsportsmanlike Conduct**  
Unsportsmanlike conduct is signalled by clenching a fist and then repeatedly tapping the top of one's head with the thumb-side of the fist.
- 3.6.21 **Breaking, False Start, or Encroachment**  
The signal is an arm extended and straight up with index finger pointing up. Hand is then rotated several times such that the index finger inscribes an imaginary circle above the head that is parallel to the surface of the water.
- 3.6.22 **Grabbing and/or Pulling on Wall Barriers**  
Signal is an open-fingered hand, fingers curved and moving back and forth in pulling motion. Signal is mimicking the grabbing of the top of an invisible barrier and shaking it.
- 3.6.23 **Infringement Seen but the Advantage Rule is in Effect**  
A signal made beneath the surface of the water in which the Referee points with the index finger, other fingers clenched into a fist, and the hand moved in a circular motion. The purpose of this call is to allow players to see that a Referee has seen an infringement and is at that moment exercising the "advantage rule." This signal is to reduce frustration and possible retaliation by players.
- 3.6.24 **Side-Line-Out or Puck Out-of-Bounds**  
Signal is a straight forearm and hand, fingers straight and together, forearm and hand held parallel to the water surface with palm facing chest, and extended away from the chest by the length of the upper arm. The other hand then makes a diving motion over the stationary forearm/hand mimicking a puck being flicked over a barrier. This signal is then to be followed by the appropriate equal puck or advantage puck signal.

## **4. THE MATCH**

### **4.1 Rules of Play**

- 4.1.1 A match is "in play" during the period between the starting and ending of play as indicated by the Chief Referee, but "out-of-play" during a time-out called by a team, an Official's time-out, the breaks between timed periods, including between the two timed over-time periods, and the break before the start of sudden death.
- 4.1.2 A player is only said to be "in possession" whilst the player's stick is in contact with the puck.
- 4.1.3 Any part of the stick, except that protruding from the heel of the protected hand, may be used to play the puck. However, the puck must not be lifted up or carried in any direction whilst balanced on the stick; and should a puck be lifted accidentally onto a stick, it must be dropped off the stick immediately.
- 4.1.4 The stick may be held in either the right or left hand; changing playing hands is allowed
- 4.1.4.1 A player may have two hands on the stick when not in possession of the puck (e.g. trying to achieve a streamlined possession when sprinting toward a puck at the centre of the playing area or trying to retrieve a dropped stick). The free hand may not be used to support the stick, stick hand, or arm whilst in possession of the puck.
- 4.1.5 Whilst a match is in play, the puck may be pushed or passed in any direction along the pool bottom anywhere within the playing area, by the player in possession. See Rule 5.2 for exception: corner rule.

- 4.1.6 At no time may a player handle the puck with the free or playing hand. Should the puck accidentally touch the back of the playing hand, this will not be considered handling the puck unless used deliberately to advance the puck.
- 4.1.6.1 The puck, while being propelled by the stick, may rest against the index finger when the hand is in its natural position of holding the stick.
- 4.1.7 When players are swimming on the surface, over-arm strokes are permitted, but only when other players are not in danger of being struck.
- 4.1.8 During the match, the four substitutes must be in their team substitution areas.
- 4.1.9 Methods of substitution are defined in rule section 4.4.

#### **4.2 Duration of Play**

- 4.2.1 An International Match shall last thirty-three (33) minutes. The match is divided into two-fifteen (15) minute periods with a three (3) minute break between.
- 4.2.2 At half-time the teams shall change ends.
- 4.2.3 Once started, timed play is continuous until the last two (2) minutes of a match, and can only be stopped by the Chief Referee in the event of a serious injury, the need to confer with the other Referees, or other special circumstance.
- 4.2.3.1 During the last two (2) minutes of a match, or the last two (2) minutes of the second over-time period (Rule 4.2.4.1), the match clock will be stopped during all breaks in play excepting a goal.
- 4.2.4 Should it be necessary to have a winning team from a match which ends in a draw, an extra ten (10) minutes will be played with a three (3) minute break between the match end and start of overtime.
- 4.2.4.1 An overtime period shall consist of two five (5) minute periods. Teams will start from the same end as they started the match.
- 4.2.4.2 When the first five (5) minute period ends, both teams shall immediately change ends. The break between these periods is one (1) minute.
- 4.2.4.3 An overtime period is part of the same match, and therefore, must be played with the same declared players as in the tied match.
- 4.2.5 If after ten (10) minutes of additional play the match remains in a draw, after a one (1) minute break with no change of ends, the match will continue without interruption until a goal is scored. The first team to score a goal wins the match.
- 4.2.6 Time-out Period:  
At all competitions, one time-out period per team per half can be called at a natural break in the play. The time-out can be called by either a Team Captain or Coach.
- 4.2.6.1 To request a time-out period, the Captain or Coach will attract the attention of either the Water Referee or the Chief Referee and request a time-out verbally by raising both arms above the head in the form of a large letter "O". The Chief Referee will acknowledge the request by repeating the signal and stopping the clock. The Water Referees will also mimic the Chief Referee's time-out signal.
- 4.2.6.2 Each time-out period will be of one (1) minute duration. At forty-five (45) seconds, the Chief Referee will give a fifteen (15) second warning.
- 4.2.6.3 Time-out is only allowed in the two normal fifteen (15) minute periods. No time-out may be called in either five (5) minute periods of overtime or sudden death time.
- 4.2.6.4 During a time-out period, the penalised players and the coaches may join their team-mates in the playing area. At the end of the time-out period the penalised players must have returned to the penalty box, and the coaches must have left the playing-area.

### **4.3 Starting Play**

- 4.3.1 At the beginning of a match, after half-time, after a goal is scored, or after a Penalty Shot has been played, the starting positions of the players of each team are in the water alongside their respective end-lines, with each player having at least one hand in contact with the end-line. This hand must be visible to the Officials.
- 4.3.2 The substitutes of each team shall be in the team's designated substitution area; and any penalised players shall be in the designated penalty box.
- 4.3.3 From the moment the Chief Referee gives the signal for play to start until the moment the puck becomes "in possession", all players, including the substitutes, who enter the match must start play as per rule 4.3.1. After the puck becomes 'in possession' by any player or team, players entering the match from the substitution area may only do so from a sitting position on the edge of the pool deck. See Rule 4.3.4 for exception.
- 4.3.3.1 A two minute penalty will be given for jumping or diving head-first from a standing position into play. For the safety of all players this will be strictly enforced. No warnings shall be given
- 4.3.4 FOR TOURNAMENTS WITH END-LINE SUBSTITUTION ONLY: From the moment the Chief Referee gives the signal for play to start until the moment the puck becomes "in possession", all players, including the substitutes, who enter the match must start play as per rule 4.3.1. After the puck becomes "in possession" by any player or team, players entering the game from behind the end-line may do so by any means including jumping or diving head-first from a standing position.
- 4.3.4.1 No penalty will be assessed for standing or headfirst dives with end-line substitution if done safely for tournaments with end-line substitution.
- 4.3.5 The starting position of the match Officials are:
- 4.3.5.1 The Chief Referee shall be on the poolside approximately in the centre of the side-line.
- 4.3.5.2 The two Water Referees shall be in the water alongside the centre of their respective side-lines.
- 4.3.6 An audible warning signal will be given thirty (30) seconds before each timed period (first period, second period, before each timed over-time period, and before the start of sudden-death overtime). At the end of the thirty (30) second period the audible signal to commence play will be given.
- 4.3.7 The Chief Referee will re-start play thirty (30) seconds after a goal has been scored or if the scoring team is prepared sooner. No thirty (30) second warning shall be given.
- 4.3.7.1 Should play be re-started for any reason before all players have reached their starting end of the playing area, they must do so before re-entering play. The hand touching the end wall must be visible to the Chief Referee.
- 4.3.8 Should play be stopped because of a rule infringement, an accident, or an injury, it shall be re-started by the Chief Referee.

### **4.4 Substitution**

- 4.4.1 There are three (3) methods of substituting players during tournaments: deck side-substitution, in-water side-substitution, and end-line substitution. Only one method can be chosen for any one tournament.
- 4.4.2 **Deck side-substitution**
- 4.4.2.1 For World Championships, only deck side-substitution is permitted.
- 4.4.2.2 Both team substitution areas must be on the same side of the playing area, marked on the pool deck, and visible from the water surface of the playing area. The preferred placement of the team substitution areas is along the side-line opposite that of the Chief Referee and Timekeeper(s)/Scorer(s) so substitution can be easily observed.

- 4.4.2.3 The side-line of the playing area, be it a barrier or pool wall, must be immediately adjacent to the team substitution areas. There may not be a neutral area between the playing area and the team substitution areas.
- 4.4.2.4 Each team's substitution areas will be the 5 metre area between 5 metres and 10 metres away from the end-line containing the goal that the team is defending.
- 4.4.2.5 A player exiting the playing area is deemed to be fully within the team substitution area when he/she has fully cleared the water surface within the bounds of the substitution area.
- 4.4.2.6 The substituting player may not enter the playing area until the exiting player is fully clear of the water. The substituting player is deemed to have left the team substitution area when he/she has made contact with the water in the playing area.
- 4.4.2.7 Substitute players may not sit with his/her leg(s) or fin(s) in the water.
- 4.4.2.8 When the puck is in play and is within 3 metres of the substitution area, substitutes entering play may only do so from a seated or crouched position on the edge of the playing area within the team substitution area. A two minute penalty will be assessed for the player jumping feet-first or diving head-first when the puck is in-play within the stated area. For the safety of all players this rule will be strictly enforced. No cautions will be given. When the puck is outside the stated 3 metre area, players will not be penalised for jumping feet-first or diving head-first into play.
- 4.4.2.9 When substitutes enter the playing area after a goal is scored or following the playing of a penalty shot, they must touch their end-line before re-entering play.
- 4.4.2.10 The four substitutes may be used while a match is underway, i.e., substituting on-the-fly, or at any natural break in the play, e.g., puck out-of-bounds, penalty, goal, half-time, or time-out period.
- 4.4.2.11 One, two, three, or four players may be substituted at a time.
- 4.4.2.12 Infringing substitute(s) will incur a two (2) minute penalty. That team will play without players equal to the number of infringing substitutes.
- 4.4.2.13 Referees will not wait for substitutes to return to their playing positions, i.e. advantage puck.
- 4.4.2.14 Players who have left the water to allow a substitute to enter the water now become substitutes themselves and must wait in their team substitution area until required.
- 4.4.3 **In-water side-substitution**
- 4.4.3.1 Both team substitution areas must be marked on the same side of the playing area. The preferred placement of the team substitution areas is the side-line opposite that of the Chief Referee and Timekeeper(s)/Scorer(s) so substitution can be easily observed.
- 4.4.3.2 The side-line of the playing area must be immediately adjacent to the substitution area. There may not be a neutral area between the playing area and team substitution area.
- 4.4.3.3 Each team's substitution areas will be located along the side-line in the 5 metre long area between 5m and 10m away from the end-line containing the goal that the team is defending.
- 4.4.3.3.1 A taught floating rope will mark the edge of the playing area, located directly above the submerged barrier or demarcation line forming the side-line, and will also define the playing area edge of the team substitution areas.
- 4.4.3.3.2 Players may not hang on the floating ropes delineating the team substitution areas.
- 4.4.3.4 A player exiting the playing area is deemed to be fully within the team substitution area when his/her snorkel breaks the water surface within the substitution area.
- 4.4.3.5 The substituting player may not enter the playing area until the exiting player's snorkel breaks the surface of the water in the substitution area. The substituting player is deemed to have left the team substitution area when his/her snorkel submerges beneath the water surface in the team substitution area.

- 4.4.3.6 When substitutes enter the playing area after a goal is scored or following the playing of a penalty shot, they must touch their end-line before re-entering play.
- 4.4.3.7 The four substitutes may be used while a match is underway, i.e., substituting on-the-fly, or at any natural break in the play, e.g., puck out-of-bounds, penalty, goal, half-time or time-out period.
- 4.4.3.8 One, two, three, or four players may be substituted at a time.
- 4.4.3.9 Infringing substitute(s) will incur a two (2) minute penalty. That team will play without players equal to the number of infringing substitutes.
- 4.4.3.10 Referees will not wait for substitutes to return to their playing positions, i.e. advantage puck.
- 4.4.3.11 Players who have left the water to allow a substitute to enter the water become substitutes and must wait in their team substitution area until required.
- 4.4.4 **End-line substitution**
- 4.4.4.1 This is the least desirable form of substitution for a tournament and will ONLY be used when side-substitution cannot be used.
- 4.4.4.2 The end-line of the team substitution areas must be immediately adjacent to the substitution area. There may not be a neutral area between the playing area and team substitution areas.
- 4.4.4.3 The team substitution area is located behind the end-line containing the goal the team is defending
- 4.4.4.4 A player exiting the playing area is deemed to be fully within the team substitution area when he/she has fully cleared the water surface within the bounds of the substitution area.
- 4.4.4.5 The substituting player may not enter the playing area until the exiting player is fully clear of the water. The substituting player is deemed to have left the team substitution area when he/she has made contact with the water in the playing area.
- 4.4.4.6 Substitute players may not sit with his/her leg(s) or fin(s) in the water.
- 4.4.4.7 The four substitutes may be used while a match is underway, i.e., substituting on-the-fly, or at any natural break in the play, e.g., puck out-of-bounds, penalty, goal, half-time or time-out period.
- 4.4.4.8 One, two, three, or four players may be substituted at a time.
- 4.4.4.9 Infringing substitute(s) will incur a two (2) minute penalty. That team will play without players equal to the number of infringing substitutes.
- 4.4.4.10 Referees will not wait for substitutes to return to their playing positions, i.e. advantage puck.
- 4.4.4.11 Players who have left the water to allow a substitute to enter the water now become substitutes themselves and must wait on the poolside at their own team's end until required.

#### **4.5 Stopping Play**

- 4.5.1 The signal to stop timed play is given by the Chief Referee upon an indication by the Time-keeper that the time period has been completed.
- 4.5.2 Play is also stopped by the Chief Referee:
- 4.5.2.1 When a goal is scored.
- 4.5.2.2 When an infringement of the rules is committed.
- 4.5.2.3 When an accident or injury occurs.
- 4.5.2.4 When there is a need to confer with the Water Referees
- 4.5.2.5 When there is a special circumstance in which the Chief Referee deems stoppage of play is appropriate.
- 4.5.3 The clock is not stopped unless otherwise indicated by the Chief Referee.

#### **4.6 Scoring Procedure**

- 4.6.1 A goal is scored only when the entire puck has wholly entered the goal volume, and makes contact with either the back and/or bottom of the frame, having been propelled by or off a stick. Should the puck enter the goal volume propelled by anything other than the stick, it shall be disallowed and the appropriate action for a rule infringement taken.
- 4.6.2 The goal volume is the volume whose width is; 120mm from the end-line of the playing area to the front edge of the trough, 180mm high by 3m long, along the length of the goal trough.
- 4.6.3 Illustrations of scoring situations in which the puck has wholly entered a goal volume and touched either the back of the goal or the bottom of the goal trough are contained in the eight (8) diagrams identified as “1” through “8” in Appendix “I”. Illustrations of no-scoring situations are found in Appendix “J”. Diagrams “1” through “4” are examples of a puck which has not wholly entered a goal volume. In diagrams “5” and “6”, although the puck has fully entered the goal volume it has neither touched the back of the goal or bottom of the goal trough.

### **5. FOUL PLAY.**

---

#### **5.1 Advantage Rule**

- 5.1.1 At any time during play, if a Referee observes an infringement against the team in possession but decides that the rule infringement does not affect the advantage held by the team in possession, **play will be allowed to continue as if the infringement had not occurred.**
- 5.1.2 If an infringement is observed and the advantage rule is being played, once play is stopped the Referee may award a delayed penalty.

#### **5.2 The Corner Rule**

- 5.2.1 The “corner” is defined as the area inscribed by an arc of 1m radius in each of the four corners on the bottom of the playing area.
- 5.2.1.1 The marked arc belongs to the corner, and once the puck makes contact with the arc the corner rule is invoked.
- 5.2.2 As a defensive manoeuvre, a defender may take the puck into the corner and hold it there until his/her team can offer support. This player can be replaced by one other who should attempt to make an effort to move the puck from the corner. But if a third player holds the puck in the corner and makes no immediate attempt to move it out, the Referee will stop play and award an advantage puck to the opposite team. Repeated use of this manoeuvre by the same team will result in player(s) having a caution (1st infringement) or two (2) minute (additional infringements) time penalty awarded against him/her.

#### **5.3 Infringements**

Players may be penalised for the following rule infringements:

- 5.3.1 Starting play incorrectly according to these rules.
- 5.3.2 Standing on the playing area in a manner that interferes with match play.
- 5.3.3 Corner rule infractions.

- 5.3.4 Having more than six (6) players in the water whilst the match is in play, or allowing a substitute to enter the water to replace a player sent out of the water for a time penalty, or one who has been dismissed for the rest of the match.
- 5.3.5 Advancing, or attempting to play the puck with anything other than the playing area of stick.
- 5.3.6 Handling the puck with the free or playing hand; this includes guiding the puck with an outstretched finger.
  - 5.3.6.1 Should the puck accidentally touch the back of the playing hand, this will not be considered handling the puck unless used deliberately to advance the puck.
- 5.3.7 Lifting or carrying the puck balanced on a stick.
- 5.3.8 Obstructing an opponent in any way whilst not in possession of the puck.
- 5.3.9 Behaving in any way or using conduct which in the opinion of the Officials can be considered contrary to the sportsmanlike conduct of the match.
- 5.3.10 Stopping or attempting to stop a goal being scored with anything other than the playing area of the stick.
- 5.3.11 Covering or obstructing the puck with any part of the body or equipment, whilst not in possession, to prevent access to the puck by other players.
- 5.3.12 Attempting to gain possession of the puck by use of obstruction.
- 5.3.13 Using hands, arms, or body in any way to grasp, pull, or push an opponent or his/her stick.
- 5.3.14 Removing or attempting to remove an opponent's equipment.
- 5.3.15 Insulting, by word or gesture, other players or the Officials.
- 5.3.16 Refusing to accept any decisions made by the Officials.
- 5.3.17 Physically attacking or deliberately hurting an opponent or striking or attempting to strike an opponent with any part of the body or equipment. This includes any action taken in retaliation.

## **6. PENALTIES.**

---

### **6.1 Action by Officials**

- 6.1.1 Should any infringement of the Rules occur, play is stopped by the Chief Referee. Play is stopped when the Chief Referee sees the Water Referee's stop play signal, or if the Chief Referee observes the infringement from his/her position.
  - 6.1.1.1 Depending on the severity of the infringement, the Referees have at their discretion the following courses of action open to them for penalising infringing players.
    - 6.1.1.1.1 They may caution the infringing player(s) (see Rule 6.2).
    - 6.1.1.1.2 They may dismiss the infringing player(s) from the water for time penalties of two or five minutes (see Rule 6.3).
    - 6.1.1.1.3 They may dismiss the infringing player(s) from the water for the rest of the match (see Rule 6.4.).
  - 6.1.1.2 In addition to penalising the infringing player(s), or as an alternative, the Referees also have the following courses of action open to them for penalising an infringing team.
    - 6.1.1.2.1 They may award an EQUAL PUCK, with neither team being awarded the advantage (see Rule 6.5).
    - 6.1.1.2.2 They may award an ADVANTAGE PUCK to the infringed team (see Rule 6.6).
    - 6.1.1.2.3 They may award a PENALTY SHOT if the infringement is committed within the 3m goal area (see Rule 6.7.).
    - 6.1.1.2.4 They may award a PENALTY GOAL to the infringed team (see 6.8).

- 6.1.1.3 Should an infringement of the rules be committed by the poolside substitutes, or the team's officials, they may also have appropriate penalties awarded against them by the Referees, i.e., a substitute will be penalized in the same manner as a player. A substitute awarded a penalty must serve it in the penalty area. In addition, the team must remove a player from the water so that the team plays short-handed for the duration of the penalty.

## **6.2 Cautioning**

- 6.2.1 For minor or accidental infringements, or any other reason deemed necessary by the Referees, once play has stopped, the Referees may verbally caution the infringing player(s) or team(s) concerned.
- 6.2.2 Once the infringing player(s) or team(s) has(have) been cautioned, the Referees will indicate whether play is to be re-started with an equal puck or an advantage puck.
- 6.2.3 In the event that a player or team is cautioned for having left the end-line before the signal to start play was given, the puck will remain at the centre and play will be re-started according to Rule 6.6.

## **6.3 Time Penalty**

- 6.3.1 For major infringements or collective minor infringements, once play has been stopped, the Referee will send the infringing player(s) to the penalty box to serve either a two (2) minute or five (5) minute time penalty.
- 6.3.1.1 Time penalty is indicated by the Referee who stopped play, pointing to the infringing player(s) and then towards the penalty box, holding up 2 or 5 fingers on the non-pointing hand to indicate the actual length of the time penalty to be served.
- 6.3.1.1.1 The actual time penalty period does not start until the infringing player(s) is(are) in the penalty box, which is situated adjacent to the Time-Keeper's table.
- 6.3.1.1.2 Players serving time penalties may not be replaced by substitutes.
- 6.3.1.2 The timing of time-penalised players is the responsibility of the Time-Keeper.
- 6.3.1.2.1 Infringing players serving time penalties must await a signal indicating expiry of the time penalty from the Time-Keeper, and the authorization of the Chief Referee, before re-entering the water at the centre-line.
- 6.3.1.2.2 A time-penalised player shall re-enter the play by gently sliding into the water at the centre line. Under no circumstances may a time-penalised player jump or dive head-first into the water whilst a match is in play.
- 6.3.1.2.3 If the time penalty is concluded whilst the play is stopped, the time-penalised player(s) may not enter the water until the puck is touched by either team.
- 6.3.1.3 Once the infringing player(s) has(have) been signalled to leave the water, the Referee who stopped play, will indicate whether play is to be re-stated with an equal puck, an advantage puck, or a penalty shot.

## **6.4 Total Dismissal**

- 6.4.1 For deliberate major infringements, or repeated unsportsmanlike conduct, once play has been stopped, the Referees will dismiss the infringing player(s) from the water for the remainder of the match, which includes any overtime periods required.
- 6.4.1.1 A total dismissal is indicated by the Referee who stopped play, pointing to the infringing player(s) and then towards the penalty box, while moving the free arm in a 90° arc with the flat of the hand face down over the top of the water.
- 6.4.1.1.1 Infringing player(s) dismissed for the remainder of the match must go to the penalty box, which is situated alongside the Time-Keeper's table, and remain there until the match is concluded.

- 6.4.1.1.2 A player dismissed for the remainder of the match may not be replaced by a substitute.
- 6.4.2 Once the infringing player(s) has(have) been signalled to leave the water, the Referee who stopped play will indicate whether play is to be re-started with an equal puck, an advantage puck, or a penalty shot.
- 6.4.3 In the event of a deliberate major infringement, or for repeated unsportsmanlike conduct by a team official (manager, assistant manager, coach, trainer, underwater coach, medical official, etc.) play will be stopped and the Referees will dismiss the infringing team official from the poolside for the remainder of the match, which includes any overtime periods required, so that the team official can no longer disrupt the match nor continue to manage, direct, or exercise influence over the team.

### **6.5 Equal Puck (See Appendix “K”)**

- 6.5.1 For any minor or accidental infringements, or any other reason thought necessary, once play has been stopped, the Referees may award an equal puck, with neither team being given the advantage, either by itself, or in conjunction with Rules 6.2, 6.3, or 6.4.
- 6.5.1.1 An equal puck is indicated by the Referee who stopped play, by both arms being crossed above the head with hands clenched into fists.
- 6.5.1.2 When an equal puck has been awarded, play recommences from the surface as follows.
- 6.5.1.2.1 The puck will be placed on the spot where the infringement occurred, provided it is never placed within 2m of a side-line and/or within 5m of an end-line.
- 6.5.1.2.2 The Water Referees will form an imaginary line across the width of the playing area aligned on the puck, and both teams must be on-side of the line with all players on the surface (i.e. with snorkel tips above the water). The players can position themselves anywhere in the playing area between the goal they are defending and the imaginary line.
- 6.5.1.2.3 One player from each team prepares to take possession of the puck, once the signal to re-commence play is given by the Chief Referee.
- 6.5.1.2.4 When both teams are in position, the Water Referees will indicate to the Chief Referee that play is to be re-commenced by raising one arm straight up in the air with the signal hand open.
- 6.5.1.2.5 Play is re-commenced on the Chief Referee’s signal, and both teams immediately attempt to take possession of the puck.

### **6.6 Advantage Puck (See Appendix “L”)**

- 6.6.1 For any rule infringement, once play has been stopped, the Referees may award an advantage puck against the infringing team, either by itself, or in conjunction with Rules 6.2, 6.3, or 6.4.
- 6.6.2 To re-start play:
- 6.6.2.1 The puck is placed at the point the infringement occurred, except when the infringement occurred away from the puck, in which case the puck is placed in the position it was when play was stopped. The puck is never placed within 2m of a side-line or within 5m of an end-line.
- 6.6.2.2 The Water Referees first align themselves on the puck, then hold up one hand in a “stop” signal with the palm facing the infringing team to indicate an advantage puck; they swim 3m away from the puck towards the infringing team and form an imaginary line across the width of the playing area behind which all players on the infringing team must retreat.
- 6.6.2.2.1 If the infringing team fails to retreat or stay behind the three (3) metre line, then as a further penalty, the puck may be advanced an additional three (3) metres towards the infringing team’s goal.

- 6.6.2.3 The offended team players prepare to take possession of the puck by positioning themselves anywhere in the playing area; and,
- 6.6.2.4 When both teams are in position, the Water Referees will indicate to the Chief Referee that play is to be re-commenced by raising one arm straight up in the air with the signal hand open.
- 6.6.3 Once the signal to re-commence play has been given by the Chief Referee, the offended team must take possession within five (5) seconds of the signal being given.
- 6.6.3.1 Should a player fail to take possession of a puck within five (5) seconds of the Chief Referee's signal to re-commence play, then this team forfeits the advantage puck. Play is then restarted with an equal puck.
- 6.6.3.2 The infringing team players may submerge but must not advance across the imaginary line until the offended team has taken possession of the puck.

### **6.7 Infringement Assessment**

#### 6.7.1 The Nature of Infringements

##### 6.7.1.1 **Minor Infringement**

- most stick infringements
- incorrect starts
- most obstruction infringements

##### 6.7.1.2 **Major Infringement**

- grasping, holding, pulling
- obscene language, abuse
- deliberate obstruction
- continued minor infringements

##### 6.7.1.3 **Serious Infringement**

- fighting, striking
- continued major infringements

### 6.7.2 Infringement Selection Procedure

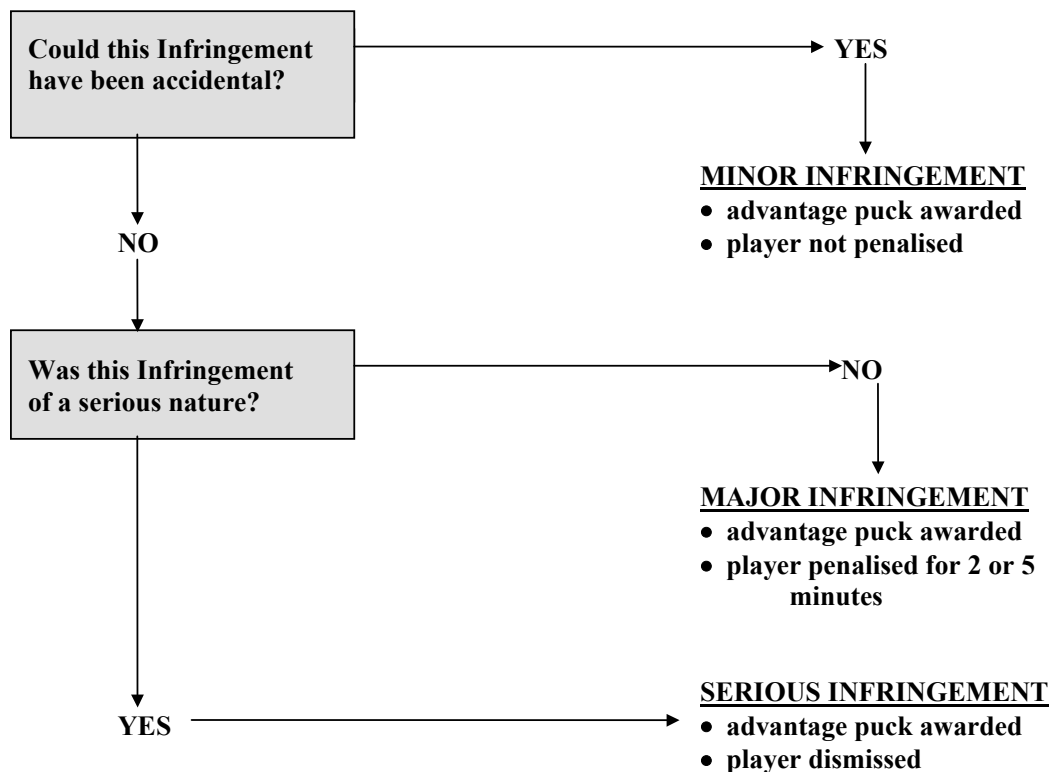

### 6.7.3 Dangerous Play

6.7.3.1 If the Water Referee deems that the puck has been deliberately played in a dangerous manner, the Water Referee will caution the infringing player and award an advantage puck, dismiss the player for a time penalty, or send the player out of the water for the remainder of the match.

### 6.7.4 Deliberate Flick Out-Of-Bounds or Side-Line-Out.

6.7.4.1 Where a player deliberately flicks a puck over a side-line boundary, the team is warned, and the infringing player is penalised. Play starts with an advantage puck.

6.7.5 Time Penalties

6.7.5.1 The following table is the list of time penalties to be awarded against offenders of the listed rule infringements.

RULE	INFRINGEMENT/FOUL	1st Infringement	2nd Infringement	3rd Infringement or More
5.3.1	Incorrect Start	Caution	2 minutes	2 minutes
5.3.2	Standing on Playing Area	Caution	2 minutes	2 minutes
5.3.3	Corner Rule Violation	Caution	2 minutes	2 minutes
5.3.6	Handling Puck with Free Hand	2 minutes	2 minutes	2 minutes
5.3.7	Lifting/Carrying Puck	2 minutes	2 minutes	2 minutes
5.3.9	Unsportsmanlike Conduct	2 minutes	2 or 5 minutes*	5 minutes
5.3.10	Illegal Stopping of Goal	2 minutes	2 minutes	5 minutes
5.3.13	Handling an Opponent	2 minutes	2 or 5 minutes or Dismissal*	5 minutes or Dismissal*
5.3.14	Removing Equipment	2 minutes	5 minutes or Dismissal*	Dismissal
5.3.15	Insults	2 minutes or Dismissal*	5 minutes or Dismissal*	Dismissal
5.3.17	Attacking/Hurting	Dismissal		

\* Depending on severity

**6.8 Penalty Shot.**

**(See Appendix “M”)**

6.8.1 Should any rule infringements occur within the 3m goal area which prevents an almost certain goal being scored, the Referee will signal the Chief Referee to stop play by raising and lowering one hand with clenched fist in a pumping action to indicate that a penalty shot is being awarded against the infringing team. The Referee, at their discretion, may also penalise the infringing player(s) with a caution, a time penalty, or a match dismissal.

6.8.2 To prepare for playing a penalty shot:

6.8.2.1 The puck is placed directly in front of the infringing team’s goal on the penalty spot, which is situated in line with the mid-point of the end-line and exactly 3m away from the end-line;

6.8.2.2 The offended team’s captain selects two (2) attackers from amongst all the players and substitutes on the offended team, who are initially both on the surface and behind the puck;

6.8.2.2.1 Player(s) in the penalty box are not eligible to participate in the penalty shot, including player(s) sent to the penalty box for the infraction resulting in the penalty shot being played.

6.8.2.3 The infringing team’s captain selects one (1) defender from amongst all the players and substitutes on the infringing team, who is initially on the surface near the mid-point of the end-line and has at least one hand in contact with the end-line wall.

6.8.2.4 All the remaining players of both teams must return to their respective substitution areas.

6.8.2.5 The Water Referees are positioned on the surface near the end-line, one at each end of the 6m dotted line bounding the penalty shot area.

6.8.3 The Chief Referee, on seeing that all persons are in their proper place, and the Water Referees have one arm raised straight up in the air with signal hand open to indicate they are ready for play to start, will give the signal for the penalty shot to be played.

- 6.8.4 Once the signal to commence play has been given, to play a penalty shot:
- 6.8.4.1 An attacking player, at their own discretion, will submerge and must take possession of the puck within five (5) seconds of the signal being given. If the player fails to take possession of the puck then the penalty shot is forfeited and the penalty shot is successfully defended;
- 6.8.4.2 Once an attacking player takes possession, play is continuous until the penalty shot is decided;
- 6.8.4.3 The other attacking player, at their own discretion, will submerge; and both attacking players will try to retain possession of the puck, score a goal, manoeuvre the puck anywhere within the penalty shot area, and prevent the defender from gaining possession and moving the puck out of the penalty shot area;
- 6.8.4.4 If either attacking player commits an infraction after the penalty shot is underway, the Water Referee who sees the infraction will take immediate action by signalling play to be stopped and advising the infringing player of the infraction. The penalty shot will be deemed to have been successfully defended by the defender, i.e. no goal will be credited, even if one was scored before the Referee could stop play.
- 6.8.4.5 The defending player, at his/her own discretion, will submerge and must keep one hand in contact with the end-line wall until an attacker has taken possession of the puck; whereupon, the defender need no longer touch the wall with one hand, and must try not only to prevent a goal being scored, but also, to gain possession of the puck in order to thrust it wholly across the 6m dotted line, i.e., out of the penalty shot area.
- 6.8.4.6 The Water Referees, at their discretion, will submerge; will insure that the attacker takes possession within 5 seconds; and will signal the Chief Referee to stop play when the penalty shot is decided, either by a goal being scored or by the puck being moved wholly out of the penalty shot area.
- 6.8.5 Once the penalty shot has been played, whether or not a goal was scored, the match will restart as per Rule 4.3.
- 6.8.6 Once a penalty shot has been awarded, it must be played, even if the match clock has expired before an official's time-suspension is invoked.
- 6.8.7 During the execution of a penalty shot, the game clock and all penalty clocks are stopped. Once a score is awarded or the penalty shot is successfully defended, the match clock and penalty clocks are re-started by the Chief Referee.

### **6.9 Penalty Goal**

- 6.9.1 Only in extreme cases, for a severe rule infringement committed anywhere in the playing area, including the goal area, and in circumstances where an almost certain goal would have been scored, once play has been stopped, the Referees may award a penalty goal to the infringed team and waive playing the penalty shot.
- 6.9.2 A penalty goal is indicated by the Water Referee stopping play, raising and lowering one hand with clenched fist in a pumping action, followed by raising both hands above the head.
- 6.9.3 When a penalty goal has been awarded, normal play will recommence again with the puck placed at the centre of the playing area as in Rule 4.3. No thirty (30) second warning will be given.

### **6.10 Side-Line-Out or Puck Out-of-Bounds (See Appendix "B" and "C")**

- 6.10.1 In a pool with no wall for a side line, if the puck goes completely out of the playing area, i.e., it passes completely over a demarcation line or barrier, the Referee will stop play and will award either an equal puck or an advantage puck against the infringing team.

- 6.10.2 The puck will be placed 2m in from where it went out-of-play, except that; whenever it goes out-of-play within 5m of an end-line, then the puck will be placed 5m in from the end-line and 2 metres in from the demarcation line.
- 6.10.3 Where a player deliberately flicks a puck over a side-line or barrier, the team is warned, and the infringing player is penalised. Play starts with an advantage puck.

### **6.11 Incorrect Starts**

- 6.11.1 Starting play early or "breaking".
- Start: Advantage puck at centre of playing area to other team.
- Equal Puck: Advantage puck to the other team.
- Advantage Puck: Back 3m further (if this occurs at 5m from the end-line, the puck is then moved sideways to the centre of the playing area).

### **6.12 Obstruction**

- 6.12.1 Also occurs when the puck is flicked forward and the opposing player turns but doesn't go for the puck.
- 6.12.2 Obstruction on an advantage puck, before the puck has been played. a player is deemed to be obstructing if the player endeavours to block another players direct line to the puck.

## **7. GENERAL.**

---

### **7.1 Pre-Match Preparation**

- 7.1.1 Before a match, the two team captains will introduce themselves to each other and to the Officials.

### **7.2 Protests and Appeals**

- 7.2.1 Should a protest be made by a Team Captain or a Team Manager about the conduct of a match whilst it is in play, the Chief Referee shall stop play, consult the Water Referees and others as may be necessary, consider the factual evidence presented, announce a decision to all parties, and resume play.
- 7.2.1.1 If a player receives a penalty, only the Team Captain can protest to the Water Referee. This will not constitute "*refusing to accept any decisions made by the Officials*"; thus, it does not merit the award another penalty for breaking Rule 5.3.16. If after receiving an explanation, the player refuses to go to the penalty box, such action may constitute refusing to accept decisions made by Officials. The player will go immediately to the penalty area, and let the Team Captain protest the matter to the Chief Referee. After consultation, and the Chief Referee's announcement of a decision, the team captain will no longer protest the issue, so that the match can be resumed. An appeal can be made following the match if necessary.
- 7.2.2 Within thirty (30) minutes of the end of a match, an official representing the team may appeal a Chief Referee's decision by giving written notice to the World Tournament Director.
- 7.2.3 A fee of 100 Euros cash, or its equivalent, must be submitted with the written notice.
- 7.2.4 All appeals properly submitted must be adjudicated on the same day they are received by a jury composed of one representative of each Federation participating in a Championship. The jury's decision is final.

**7.3 Match Abandonment**

- 7.3.1 In the event of a match having to be abandoned, the Chief Referee shall decide what subsequent action shall be taken.
- 7.3.2 The Chief Referee’s decision is final.

**7.4 Ruling Body**

- 7.4.1 The Ruling Body for all International Underwater Hockey Matches shall be the CMAS Underwater Hockey Commission.
- 7.4.2 Any inquires concerning the rules by which international matches are played should be addressed to the current Rules Director for Underwater Hockey.

**8. AMENDMENT OF RULES.**

---

- 8.1 Opportunity to propose, discuss and approve rule amendments is provided whenever several Federations participate in CMAS World Underwater Hockey Championships during which meetings of the Underwater Hockey Commission are convened.
- 8.2 Amendments to the rules may be proposed by any Federation at any time between World Championships. The Federation will forward in writing, their proposed amendment(s) together with reasons justifying the rule change to the Rules Director for distribution to all participating Federations in good standing with CMAS. A ballot will be included on which Federations will record their vote, their reasons for accepting/rejecting the proposed rule change, and the signature of the person authorized to cast the vote. Whenever votes are taken between World Championships, they will be conducted by double registered mail.
  - 8.2.1 A Federation which requests a postal vote must submit US\$50.00 with the proposal to support the postal costs.
- 8.3 Votes will be returned to the Rules Director. A simple majority of fifty per cent of the returned votes plus 1 is required for a rule amendment to be approved. The Rules Director will announce the results of a vote within two weeks after the deadline to receive ballots.
- 8.4 In order to be in force for a World Invitational Tournament or a World Championship, approved rule amendments must be distributed to all Federations by double registered mail (where applicable) at least six (6) months in advance of a world event.
- 8.5 A rule may be amended and be immediately implemented at a Meeting of the Underwater Hockey Commission or Rules Subcommittee prior to a World Championship, if all delegates of competing Federations at the Championships are given two (2) days written notice of such rule amendment and a unanimous vote is received at such meeting.
- 8.6 Rule changes - Agreed Procedure:

	6 Months	12 Months	6 Months	
World Cham-pion-ships	Write-up new rules and send out New Rule Book	Present New Rule Proposals	New proposals sent out to all countries for trailing	World Cham-pion-ships

- 8.7 After a World Championship the Rules Director has 6 months to write up the new rules and include them into the rule book, then post the rule book to all participating countries. FAX or e-mail may also be used to distribute the rule book. The countries then have a further 12 months to present to the Rules Director proposed rule changes or guidance notes. The Rules Director then must distribute all the proposals 6 months prior to the World Championships. Countries then will try all the proposals and then vote on them at the next World Championship.

## **9. GUIDANCE NOTES.**

---

### **9.1 Definitive Text**

9.1.1 The original text of these rules is the English text.

### **9.2 Tournament Play Schedule**

#### **9.2.1 Eight day or fewer schedule.**

##### 9.2.1.1 General

9.2.1.1.1 Each team will play no more than two (2) matches per day.

9.2.1.1.2 Eight (8) playing days are allowed.

9.2.1.1.2.1 Five and one-half days (5.5 days) for play.

9.2.1.1.2.2 Two and one-half days (2.5 days) for play-offs.

##### 9.2.1.2 Number of teams in tournament.

9.2.1.2.1 If twelve (12) or fewer teams participate in a division, a full round robin will be scheduled.

9.2.1.2.2 If thirteen (13) or more teams participate in a division, a split round robin will be played. Seeding of teams will be necessary.

##### 9.2.1.3 Seeding.

9.2.1.3.1 Seeding will be based on final placing at the immediately previous World Championships.

9.2.1.3.2 In any division with thirteen to nineteen teams (13-19), play will be divided into two (2) Sections, A and B.

9.2.1.3.2.1 Section A will consist of the top eight (8) seeded teams from the immediately previous World Championships.

9.2.1.3.2.2 Section B will consist of the remaining previously participating teams plus new and/or non-participating teams seeded by draw.

##### 9.2.1.4 Section Play.

9.2.1.4.1 Section A will play a full round robin (7 matches each).

9.2.1.4.2 Section B will play a full round robin.

9.2.1.4.3 Inter-Section play will be scheduled (a maximum of ten (10) total matches/team) to allow maximum mixing of the Sections in the round robin.

9.2.1.4.3.1 Inter-section matches do not count toward play-off status, excepting for forfeits which will incur a 2 point penalty against points awarded in round robin play.

9.2.1.4.4 Matches will be scheduled to spread play as evenly as possible, but some teams may play one match less depending on the number of entries.

9.2.1.4.5 Inter-Section matches will be assigned by random drawing at a meeting with team representatives present as early as possible during the practice week.

9.2.1.5 Points to determine play-off status.

9.2.1.5.1 Points awarded as follows:

**Intra-Section Match Points**

Win = +2 points

Tie = +1 point

Loss = 0 points

Forfeit = -2 points

**Inter-Section Match Points**

Win = 0 points

Tie = 0 points

Loss = 0 points

Forfeit = -2 points

9.2.1.6 Sectional Play-offs.

9.2.1.6.1 The top four (4) Section B teams will play the bottom four (4) Section A teams.

9.2.1.6.2 The 5th Seed from Section A plays the 4th Seed from Section B; the winning team becomes the 5th Seed in the Championship bracket, and the losing team becomes the 4th Seed in the consolation bracket.

9.2.1.6.3 The 6th Seed from Section A plays the 3rd Seed from Section B; the winning team becomes the 6th Seed in the Championship bracket, and the losing team becomes the 3rd Seed in the consolation bracket.

9.2.1.6.4 The 7th Seed from Section A plays the 2nd Seed from Section B; the winning team becomes the 7th Seed in the Championship bracket, and the losing team becomes the 2nd Seed in the consolation bracket.

9.2.1.6.5 The 8th Seed from Section A plays the 1st Seed from Section B; the winning team becomes the 8th Seed in the Championship bracket, and the losing team becomes the 1st Seed in the consolation bracket.

9.2.1.7 Championship Play.

9.2.1.7.1 The Championship bracket consists of the top four Sectional Play-off winners plus the top four Section A teams.

9.2.1.7.2 The Championship bracket will play a "Multilevel Tournament with Eight Entries" play-off with complete losers bracket determining all places (see Appendix O).

9.2.1.7.3 There will be a consolation bracket for all remaining teams, so all participating teams are seeded for the following World Championships.

9.2.2 **Nine day or more schedule**

World Championships have historically been held over a two week period. Through 2002 (Calgary) the tournament itself was restricted to the last eight days of that period. The time interval before those eight days was used for “Championship Orientation” by Federations to become adjusted to time-zone changes and pool-bottom conditions. At the Underwater Hockey Commission Meeting in Calgary (2002) attended by CMAS Secretary Generale Pierre Dernier MD, it was voted unanimously that the Championship Orientation could be limited to a minimum of three days in order to allow more than eight tournament days so additional teams in divisions and/or additional Federations could participate in the two week festival.

9.2.2.1 A minimum of 3 days will be allowed for Championship Orientation

9.2.2.2 Teams may not play more than 2 games per day

9.2.2.3 The hosting federation must submit a tournament schedule of the World Championship to the voting members of the Underwater Hockey Commission for approval. The vote will be conducted by the CMAS Rules Director, and the tournament schedule must receive a majority (50% plus 1) of possible Commission votes. The vote may be conducted by e-mail.

### 9.3 Rule Directors by Federation

Note: This list is as current as possible but may not be accurate due to changes in the internal structure and procedures of the participating Federations.

NAME	POSITION	FEDERATION
<b>Alberto Gonzalez</b> Arribeños 1599 piso 15 Dto B (1425) Ciudad de Buenos Aires Argentina	Federation Rules Director and Chief Referee	Argentina
<b>Simon Talbot</b> PO Box 668 Sandy Bay TAS 7006 Australia	Chief Referee	Australia
<b>Jan Dautzenberg</b> Cannerweg 272 6213 BL MAASTRICHT, Netherlands	Rules Manager	Belgium
<b>Margaret Frances</b> 4010 Stanley Road SW Calgary, Alberta T2S 2T4 Canada	Chief Referee	Canada
<b>David Puentes</b> Arpartado Aero 20377 Cali Columbia	Director Comité Deportivo	Colombia
<b>Gilles Renaison</b> Saint Phy 97120 Saint-Claude Guadeloupe France	Federation Rules Director Assistant World Rules Director	France
<b>Alexander Molier</b> Eichendorffring 107Y 135 35396 Giessen FRG Germany	Contact Person	Germany
<b>Hugh Nolan</b> Irish Underwater Council 78a Patrick St., Dun Laoighaire, Co. Dublin Ireland	Contact Person	Ireland
<b>Leone Tarozzi</b> V. Santo Stefano 43 40125 Bologna Italy	Contact Person	Italy



NAME	POSITION	FEDERATION
<b>Erwin Post</b> Copernicusstraat 130 2561 XC The Hague The Netherlands	Rules Director	Netherlands
<b>Robert Feist</b> 16 Strode Street Dunedin New Zealand	Co-Coordinator of Referees Training	New Zealand
<b>Marilen Carpio</b> 375 Columbia Greenhills East Mandaluyong City 1550 Philippines	Rules Director	Philippines
<b>Rudi Brajdic</b> Adamiceva Ulica 2 1117 Ljubljana Slovenia	Contact Person	Slovenia
<b>Piet Joubert</b> Roger Street 13 Durbanville Cape Town Republic of South Africa 7750	Underwater Hockey President	South Africa
<b>Laurent Alquier</b> Gran Via 575 Barcelona 08011 Spain	Committee President	Spain
<b>Neil Dixon</b> 19 Collville Terrace Thorpe Wakefield West Yorkshire WF3 3DZ United Kingdom	Chief Referee Assistant World Rules Director, English Version	United Kingdom
<b>Bert Dolan</b> 9004 Vance St. #304 Westminster, CO 80021 United States	Rules Director	United States
<b>Bozana Ostojic</b> Borska 40/219 11193 Beograd Yugoslavia	Contact Person	Yugoslavia

*William (Woody) Lee*

#### 9.4 Members of the Underwater Hockey Commission

NAME	POSITION	Federation
<b>Ulysse Muñoz</b> Bat. A - Le Clos St. Marc 83330 Le Beausset France	President, Underwater Hockey Commission	France
<b>Carol Rose</b> 53C Appian Way South San Francisco CA 94080-5538 USA	Secretary, Underwater Hockey Commission	United States
<b>Graham Henderson</b> Apartment 183 538 Little Lonsdale Street Melbourne Australia 3000	World Tournament Director (non-voting member)	Australia
<b>Murray Brooks</b> 19 Heyington Way, Parklands Dannemore, Auckland New Zealand	World Tournament Referee	New Zealand
<b>Jean Gatignol</b> rue du Printemps 75017 Paris France	Assistant World Tournament Referee (non-voting member)	France
<b>Woody Lee</b> Smithsonian Marine Station 701 Seaway Dr. Fort Pierce, FL 34949 USA	World Rules Director (non-voting member)	United States
<b>Neil Dixon</b> 19 Collville Terrace Thorpe Wakefield West Yorkshire WF3 3DZ United Kingdom	Assistant World Rules Director, English version	United Kingdom
<b>Maria Callado Egea</b> Orchideeveld 11 2914 PM Nieuwerkerk aan den IJssel The Netherlands	Assistant World Rules Director, Spanish version (non-voting member)	Netherlands
<b>Gilles Renaison</b> Saint Phy 97120 Saint-Claude Guadeloupe France	Assistant World Rules Director, French Version (non-voting member)	France



<b>Yannick Morin</b> 31, rue de la Carrière Rennes 35000 France	Development and Promotion of Underwater Hockey (non-voting member)	France
<b>John McBride</b> 609 Greycedar Crescent Mississauga, Ontario L4W 3J3 Canada	Member, Underwater Hockey Commission	Canada
<b>Jeremy Cliff</b> Natal Sharks Board Private Bag 2 Umhlanga 4320 South Africa	Member, Underwater Hockey Commission	South Africa
<b>Dick Trap</b> P.O. Box 75823 1070 AV Amsterdam Holland Netherlands	Member, Underwater Hockey Commission	Netherlands

A handwritten signature in black ink that reads "William (Woody) Lee". The signature is written in a cursive style.

**9.5 CALGARY 2002 RULES MEETING PARTICIPANTS AND VOTING DELAGATES†**

Chair: Woody Lee, World Rules Director

Australia: Simon Talbot\*

Argentina: Proxy to Murray Brooks\*, New Zealand, World Tournament Referee

Canada: Margaret Francis\*

Columbia: Nadia Beboya\*

France: Gilles Renaisson\*

Ulysse Muñoz

Thomas de Trébons

Jean Gatignol

Ireland: Proxy to Graham Henderson, Australia, World Tournament Director

Italy: Donato Puggioli\*

Netherlands: Dick Trap\*

Luc Oude Reimer

New Zealand: Ray Dolman\*

Lincoln Senior

South Africa: George Watson\*

Anton Louw

Philippines: proxy to Carol Rose\*, USA, Secretary of Underwater Hockey Commission

United Kingdom: Neil Dixon\*

USA: Joe Gomes\*

Dr. Ken Kelson, Medical Advisor and Authorized Drug Test Administer

At Tournament but did not participate: Turkey  
Spain

† At start of meeting. Participants departed and replaced due to Federation pool practice schedules as meeting progressed.

\* Authorized Federation voting member at start of the meeting

•Here ends the text of the Rules, known as the 8th Edition, Version 8.20. This edition supersedes all previous editions.

Anyone requiring use of images published in this document can contact the Technical Editor (Jamie Phillips) via e-mail at [jamie@petrellyn.com](mailto:jamie@petrellyn.com) or visit his website at <http://www.petrellyn.com>.

**Woody Lee**

Smithsonian Marine Station  
701 Seaway Dr.  
Fort Pierce, FL 34949  
USA

World Rules Director

**Gilles Renaison**

Saint Phy  
97120 Saint-Claude  
Guadeloupe  
France

Assistant World Rules Director,  
French Version

**Neil Dixon**

19 Collville Terrace  
Thorpe  
Wakefield  
West Yorkshire  
WF3 3DZ  
United Kingdom

Assistant World Rules Director,  
English Version

**Maria Callado Egea**

Orchideeveld 11  
2914 PM Nieuwerkerk aan den Ijssel  
The Netherlands

Assistant World Rules Director,  
Spanish Version

**Jamie Phillips**

Passeig Valldaura 178,  
Casa 1, 3 ° 3<sup>a</sup>  
08042 Barcelona  
Spain

Assistant World Rules Director,  
Technical Editor

**APPENDIX "A" PLAYING AREA DIMENSIONS**

Minimum area of 300 square metres.  
The pool bottom must be flat or gently sloping with a maximum gradient of 1 to 20.

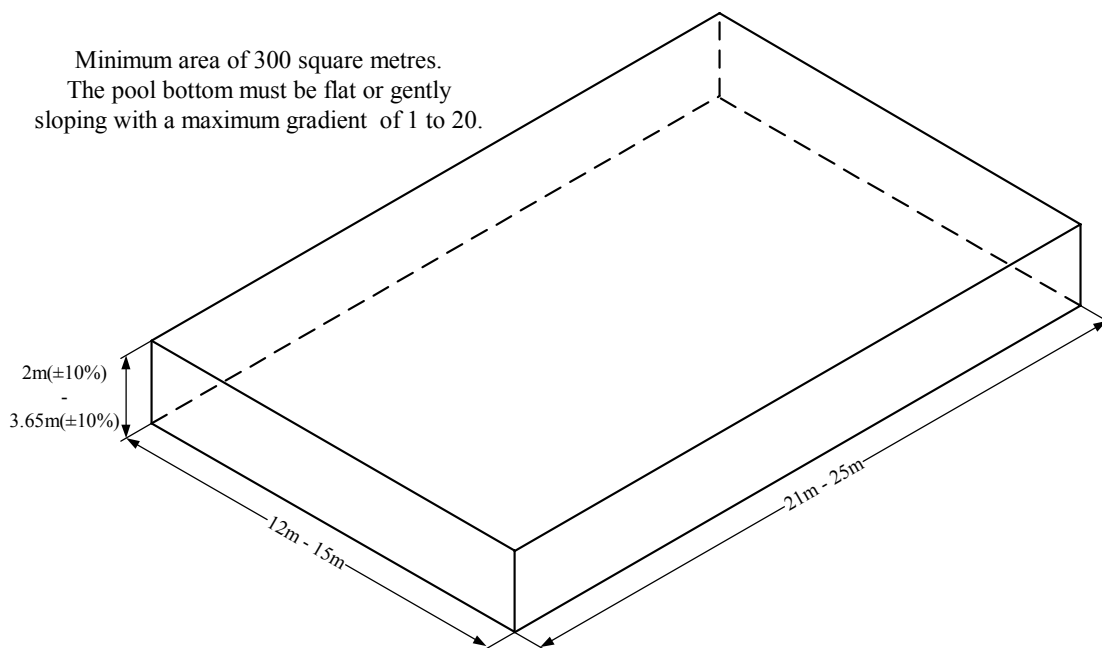

\*The depth of the water shall be between 2m and 3.65m, with a  $\pm 10\%$  allowance with the approval of the Games Commissioner. Pools shallower than 2m must be considered "fast and safe" by the World Tournament Director

**APPENDIX "B"**

**PLAYING AREA MARKINGS**

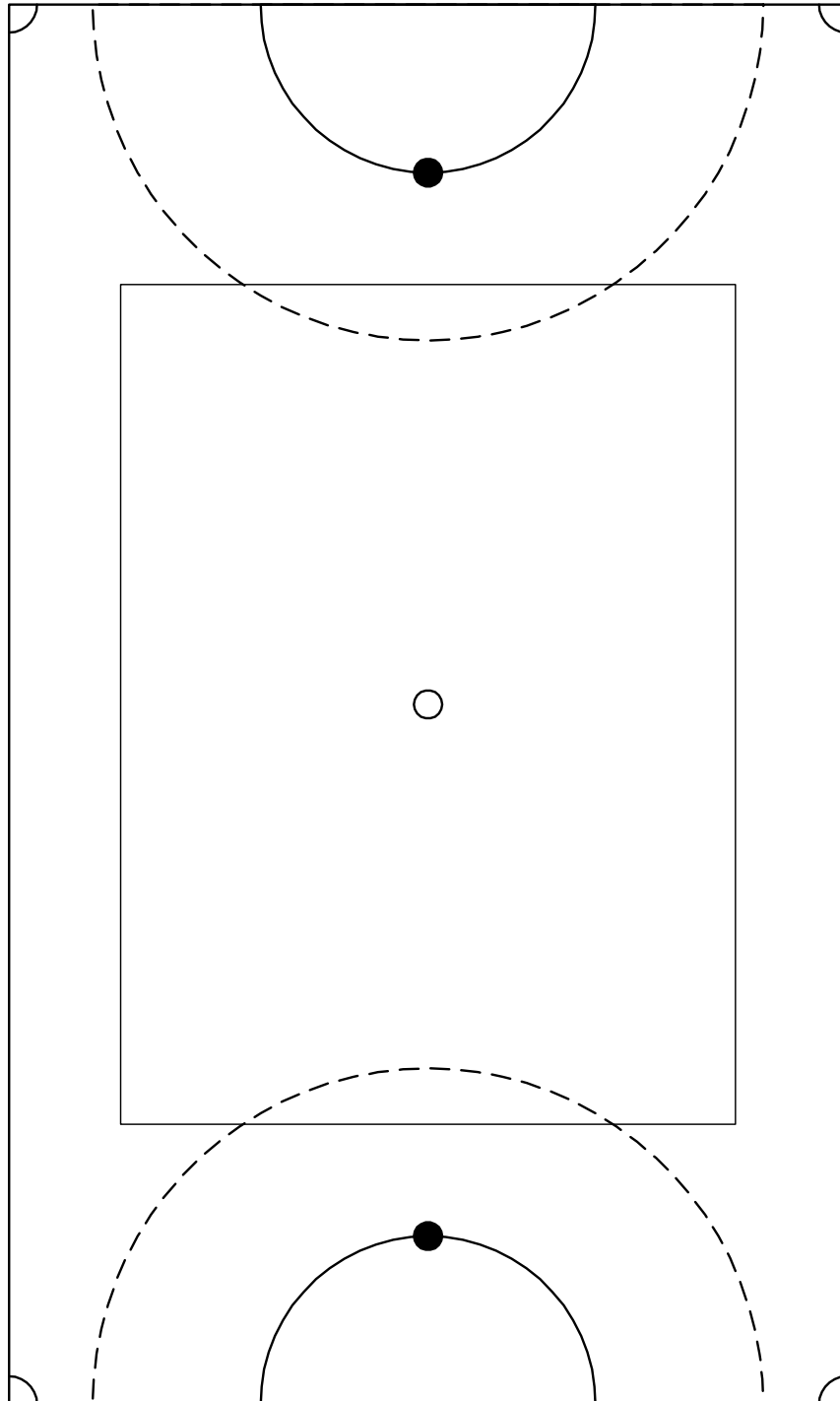



**APPENDIX "C" PLAYING AREA LAYOUT,  
DECK SIDE-SUBSTITUTION**

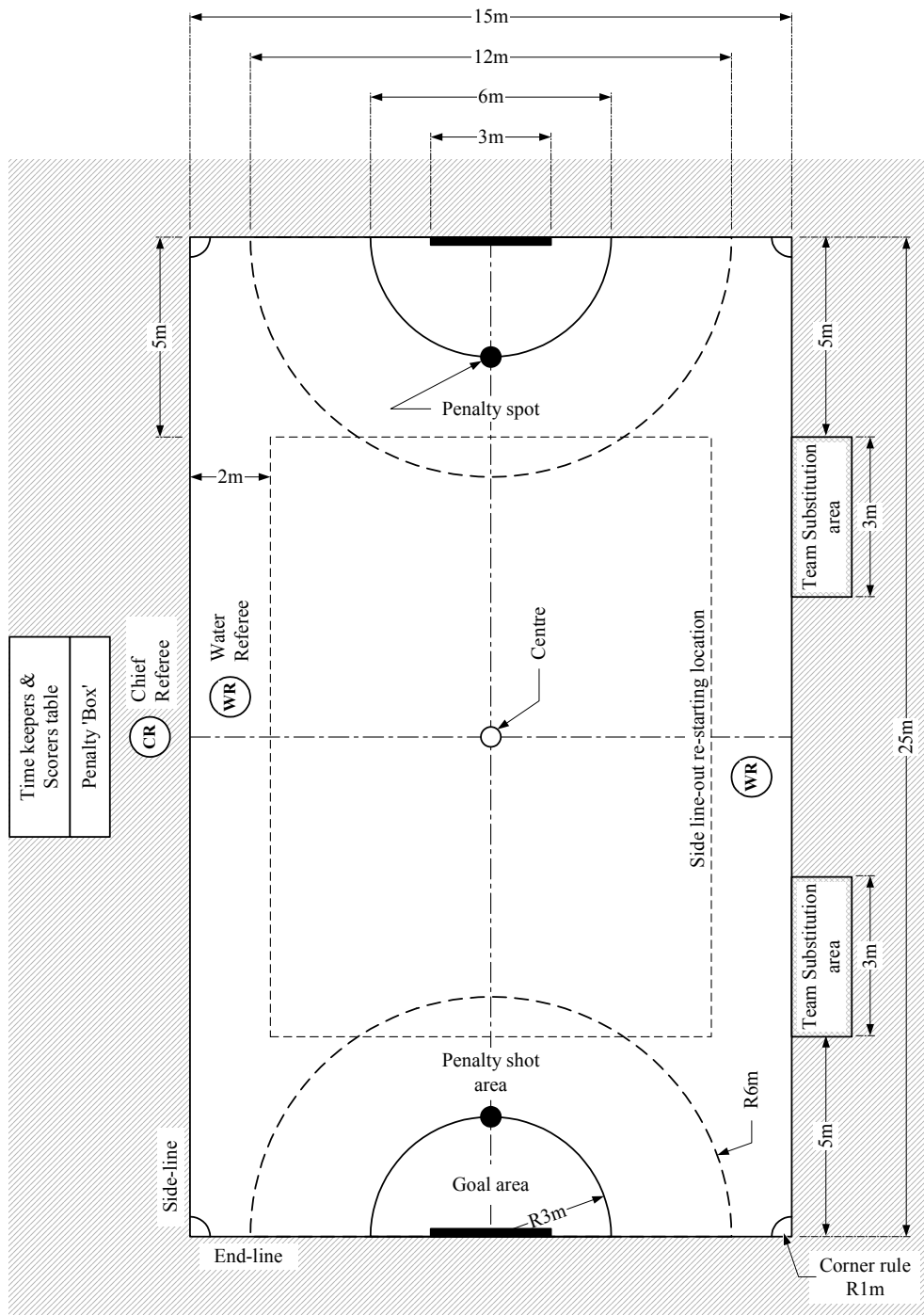

**APPENDIX "D" PLAYING AREA LAYOUT,  
IN-WATER SIDE-SUBSTITUTION**

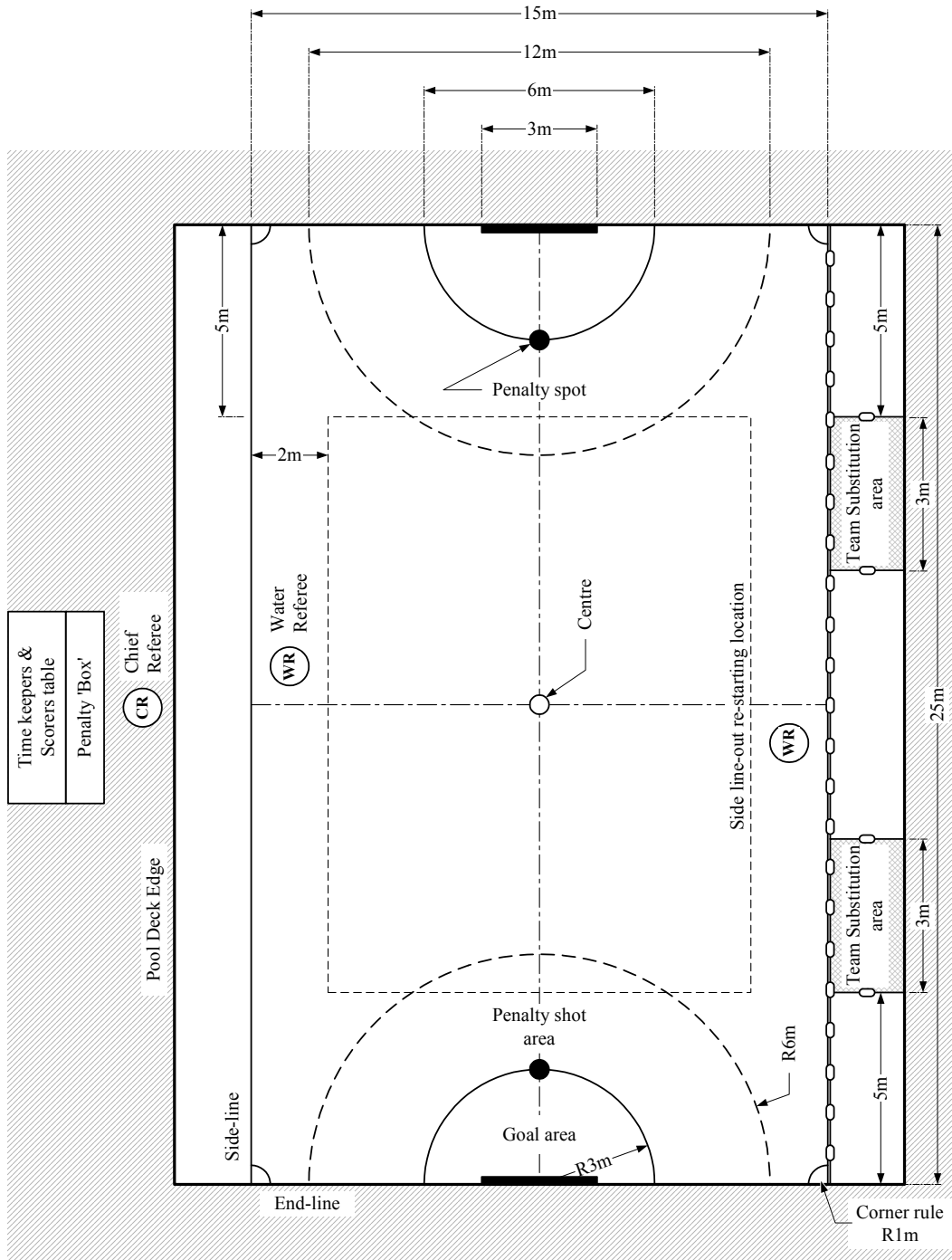

**APPENDIX "E"**

**PLAYING AREA LAYOUT,**  
**END-LINE SUBSTITUTION**

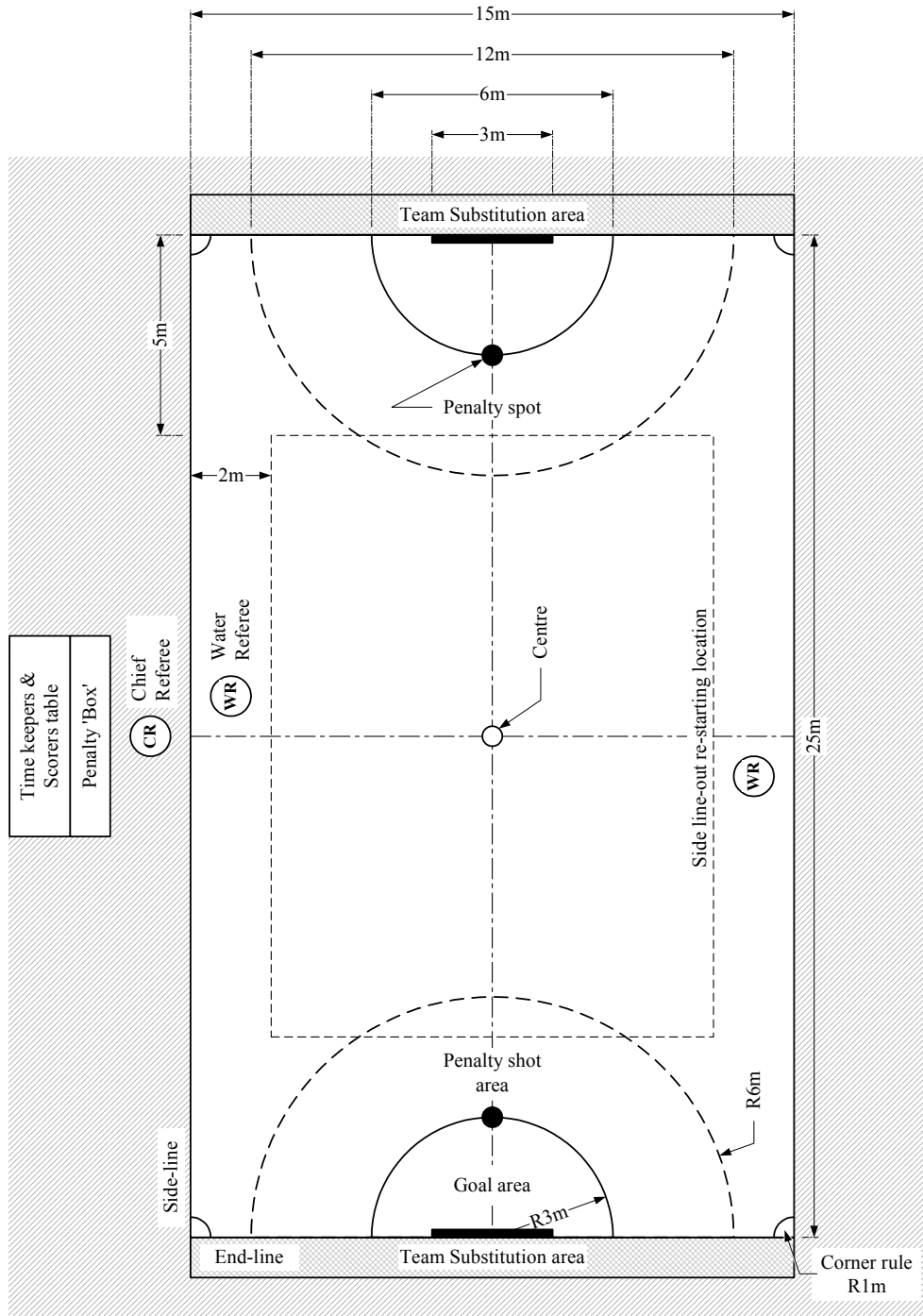



**APPENDIX "F" THE GOALS**

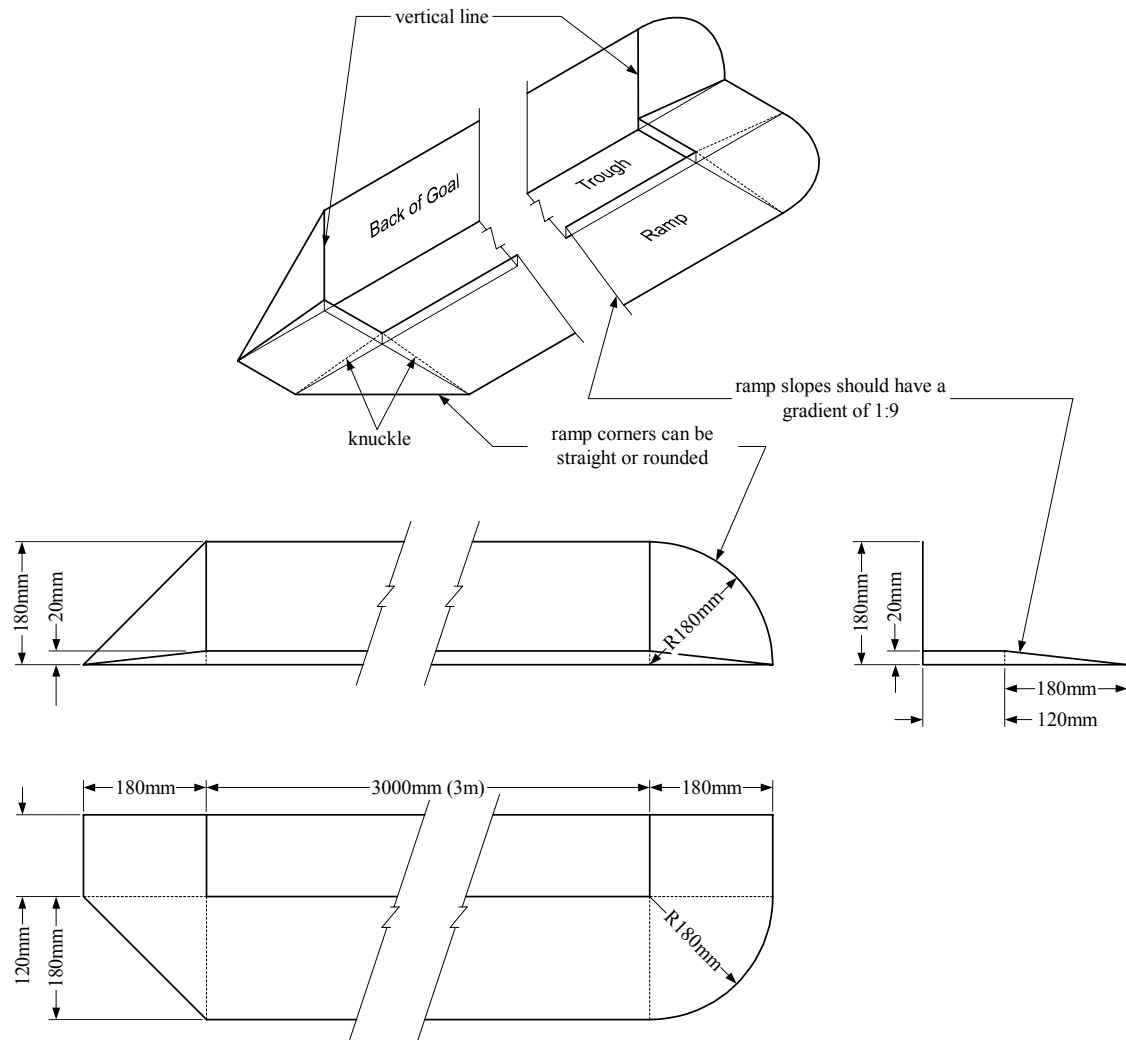

**APPENDIX "G"**

**THE PUCK**

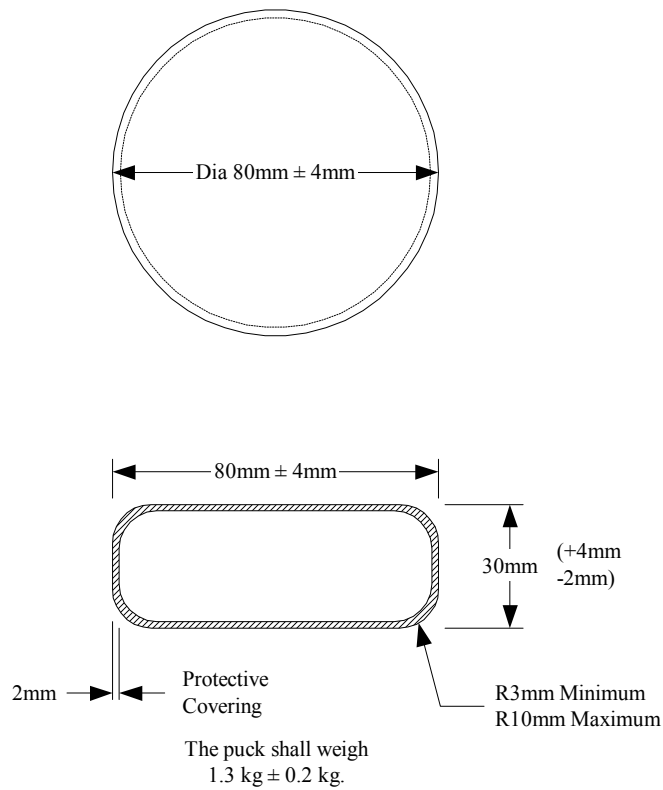

**APPENDIX "H"**

**THE STICK**

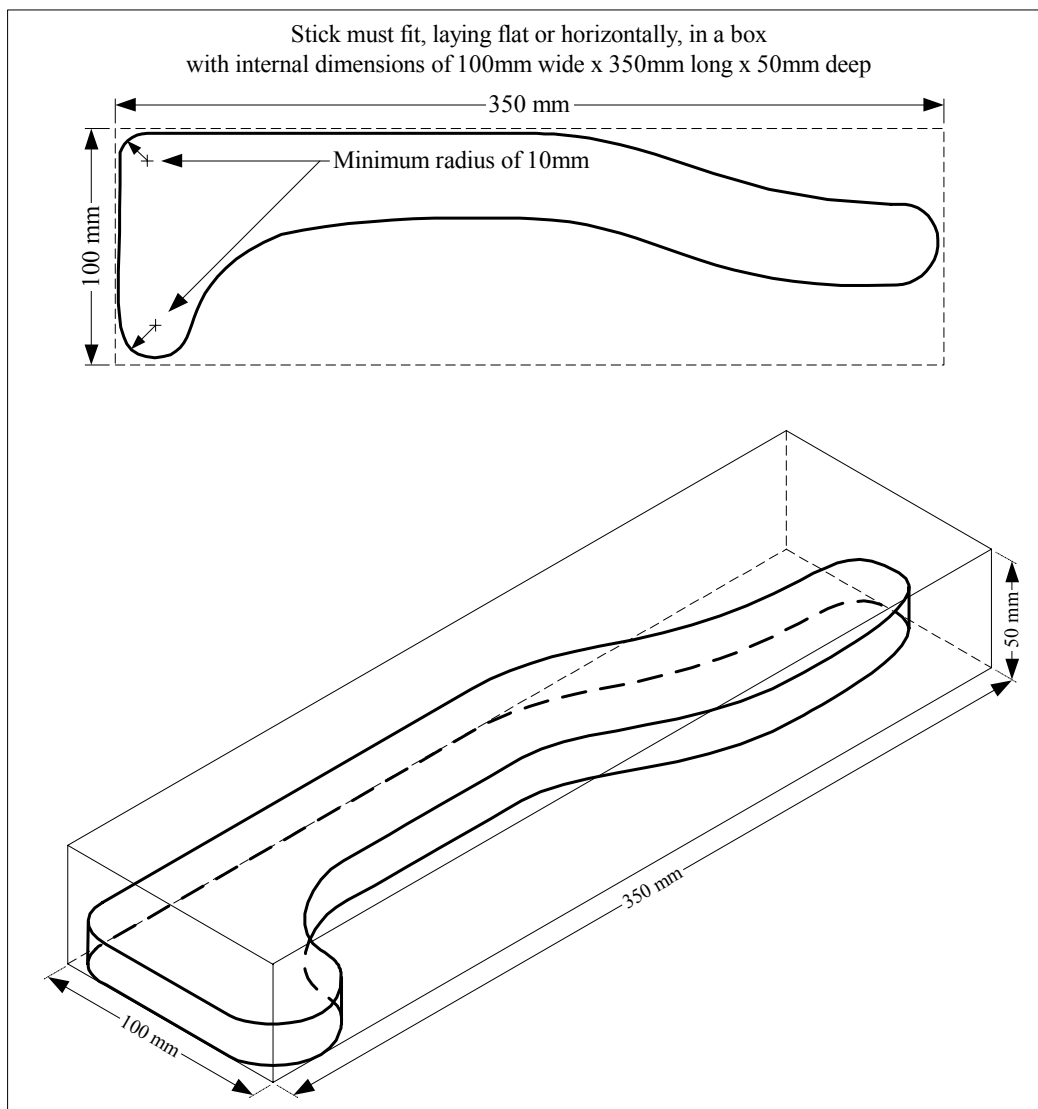

(drawing not to scale)

- The stick must fit in a box 100mm x 350mm x 50mm.
- Minimum corner radius around the perimeter edge of the entire stick is 10mm.
- Edges where surfaces intersect must be rounded.
- The stick must be uniformly black or white.
- The stick may be of any shape or design within the minimum and maximum dimensions given. The illustration is only a guide. Knob(s) on stick is/are allowed.
- The stick must not be capable of surrounding the puck or any part of hand, nor encapsulating the puck by more than 50%, or locking the puck to the stick.



**APPENDIX "I" SCORING ASSESSMENT: SUCCESSFUL**

# GOAL

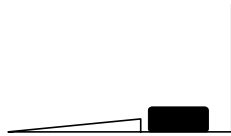

(A)

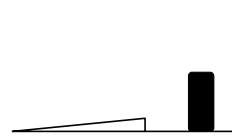

(B)

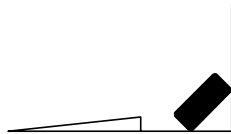

(C)

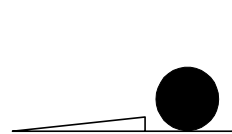

(D)

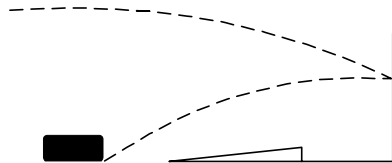

(E)

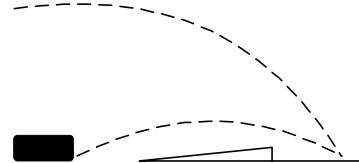

(F)

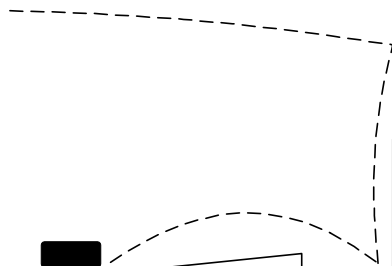

(G)

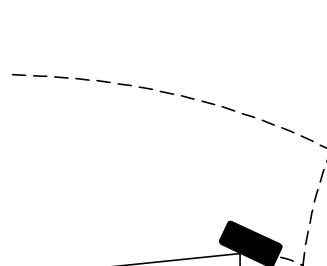

(H)

**APPENDIX "J" SCORING ASSESSMENT: NOT SUCCESSFUL**

# NO-GOAL

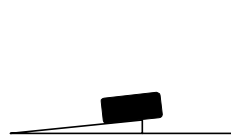

(I)

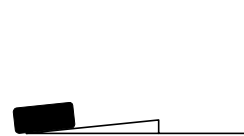

(J)

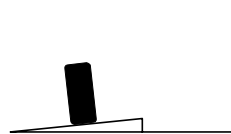

(K)

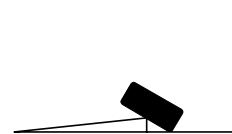

(L)

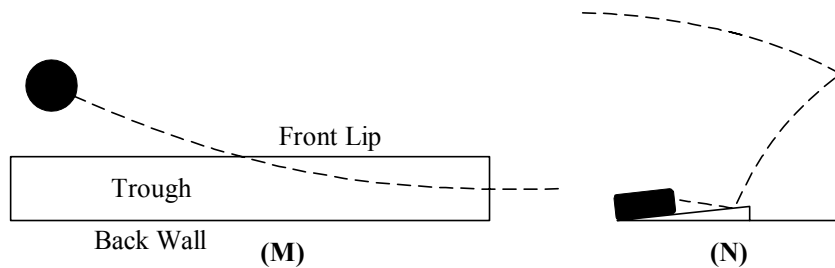

(M)

(N)



**APPENDIX "K"**

**EQUAL PUCK**

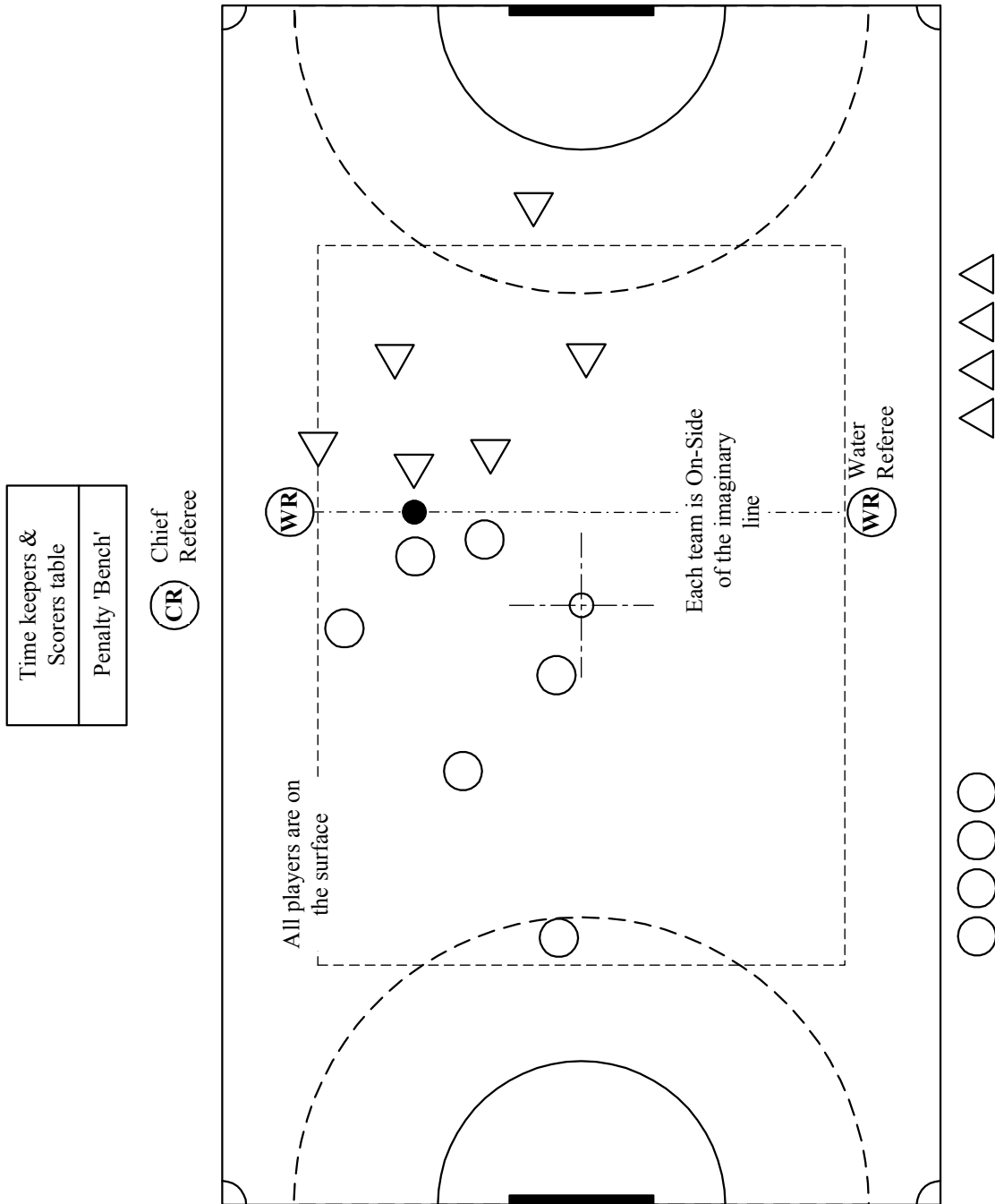

**APPENDIX "L"**

**ADVANTAGE PUCK**

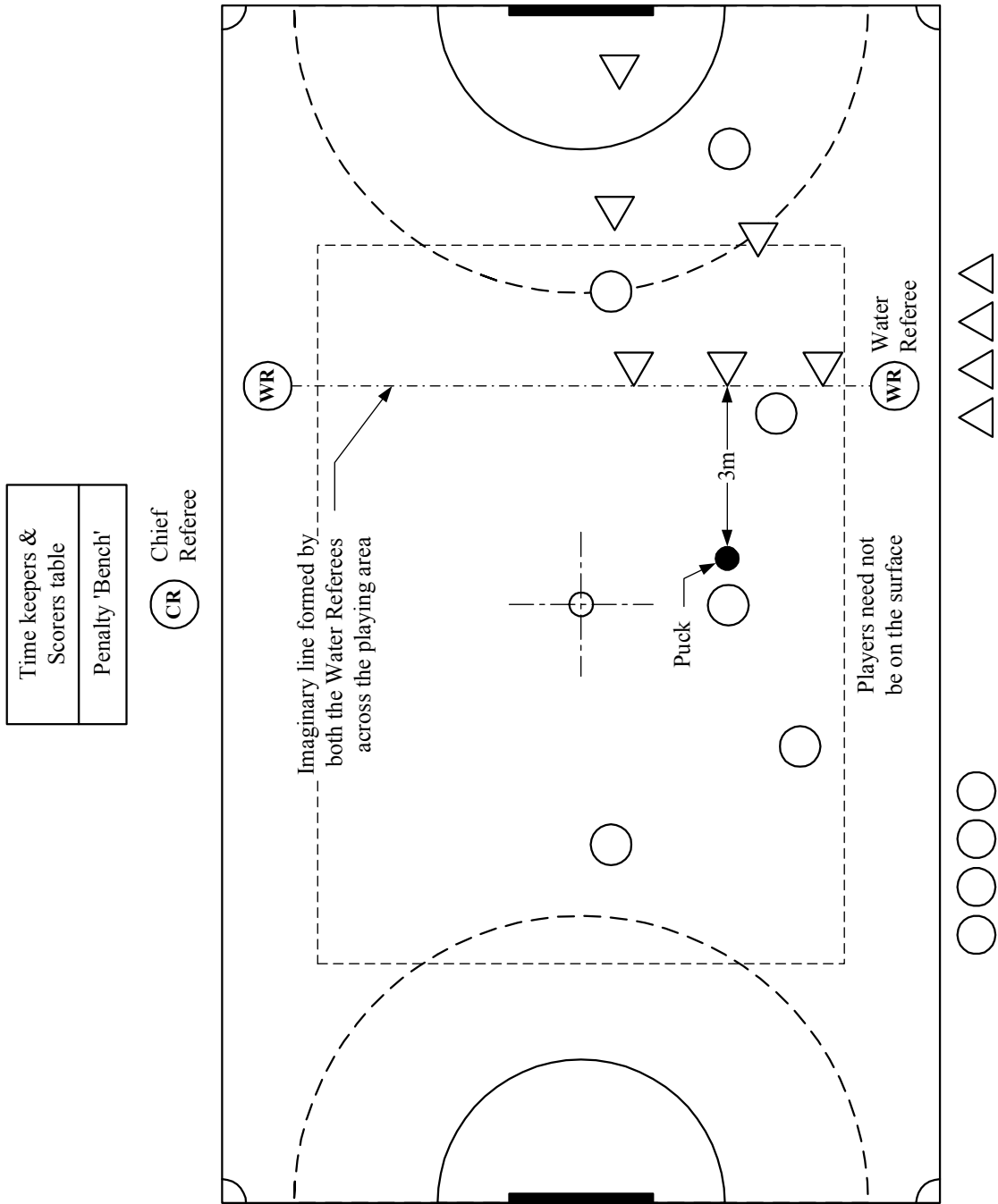

**APPENDIX "M"**

**PENALTY SHOT**

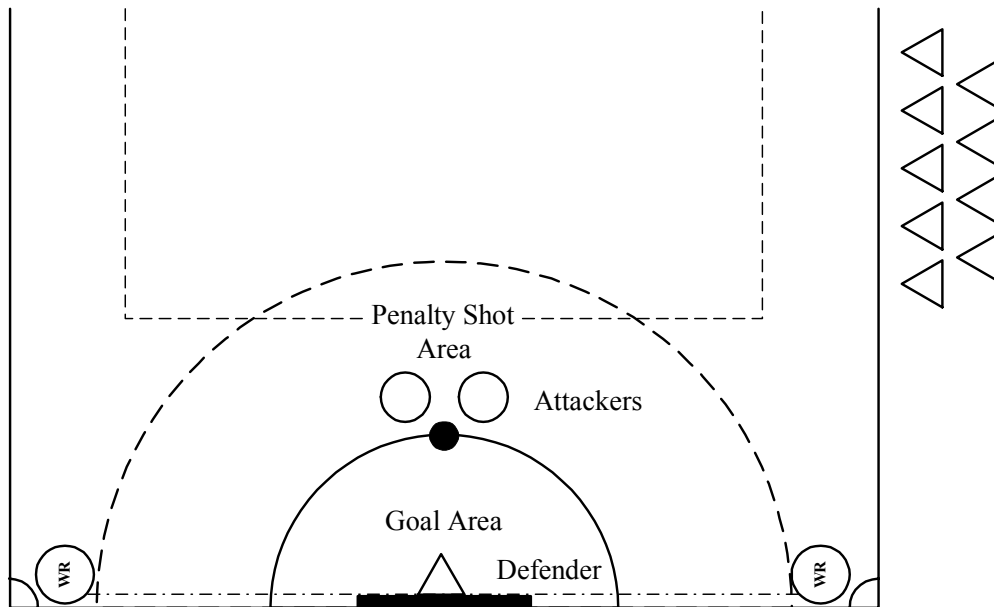

ALL OTHER PLAYERS MUST RETURN TO THEIR RESPECTIVE SUBSTITUTION AREA



**APPENDIX “N”** **SIGNALS**

**3.6.1 Ready to Start Play**

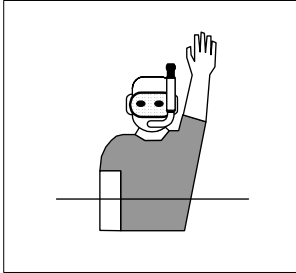

**3.6.2 Stop Play**

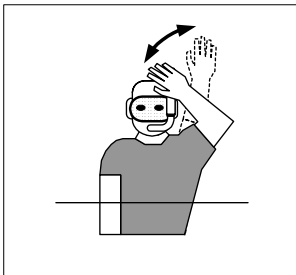

**3.6.3 Time**

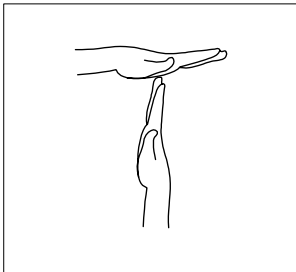

**3.6.4 Equal Puck**

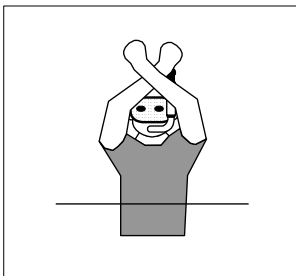

*William (Woody) Lee*



**APPENDIX “N”**

**SIGNALS**

**3.6.5 Advantage Puck**

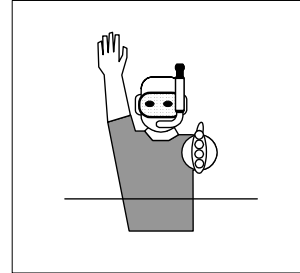
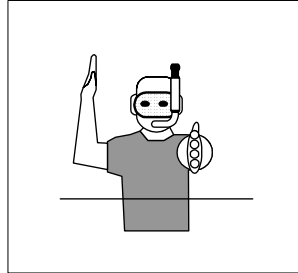
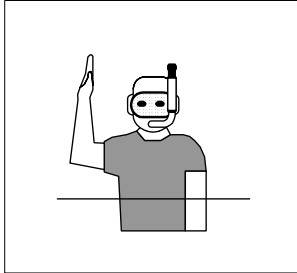

**3.6.6 Time Penalty**

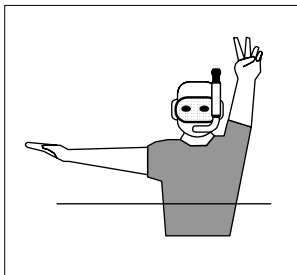

**3.6.7 Total Dismissal**

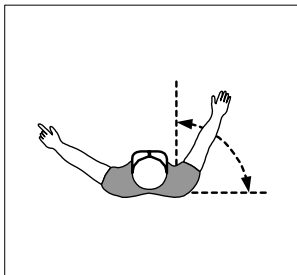

**3.6.8 Goal**

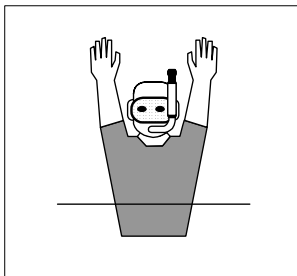



**APPENDIX "N"**

**SIGNALS**

**3.6.9 No Goal, or Goal Successfully Defended (Penalty Shot)**

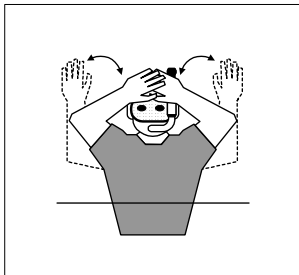

**3.6.10 Penalty Shot**

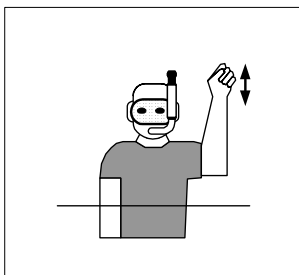

**3.6.11 Penalty Goal**

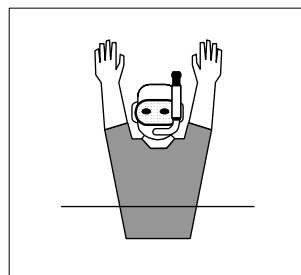
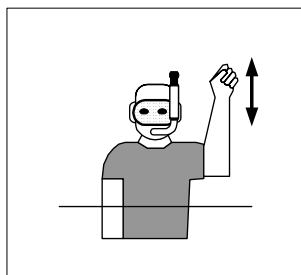
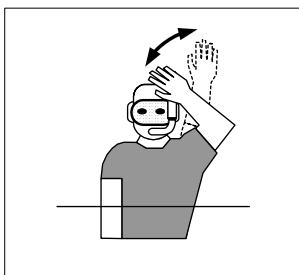

**3.6.12 Time-Out**

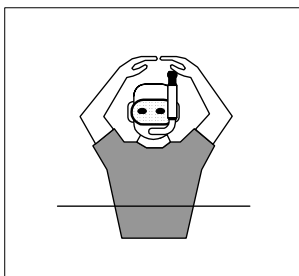



**APPENDIX “N”**

**SIGNALS**

**3.6.13 Illegal Use of Free Arm**

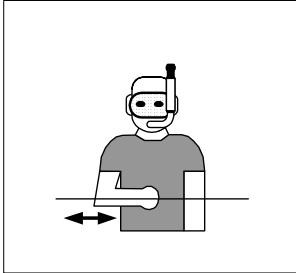

**3.6.14 Obstruction, Barging, Blocking, Shepherding**

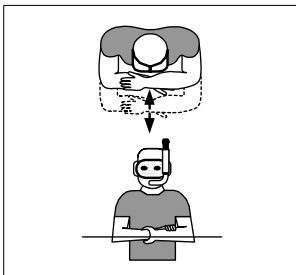

**3.6.15 Advancing the Puck with the Free Hand or Stick Infringements**

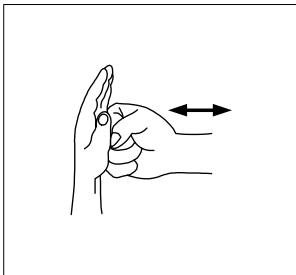

**3.6.16 Illegally Stopping the Puck**

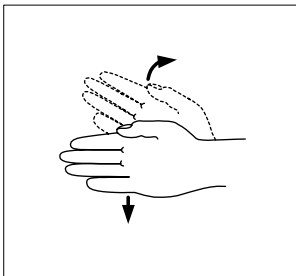



**APPENDIX "N"**

**SIGNALS**

**3.6.17 Call by Referee**

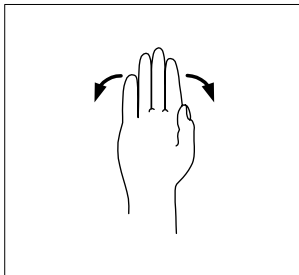

**3.6.18 Time Suspension**

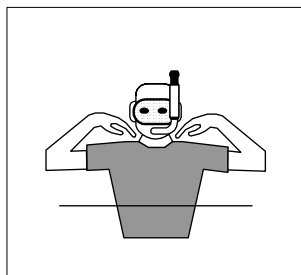
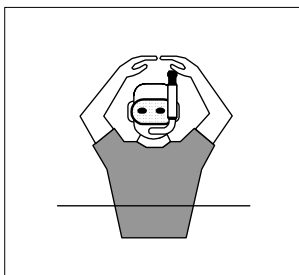

**3.6.19 Illegal Substitution**

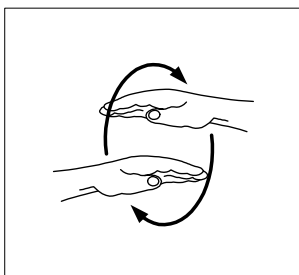

**3.6.20 Un-Sportsmanlike Conduct**

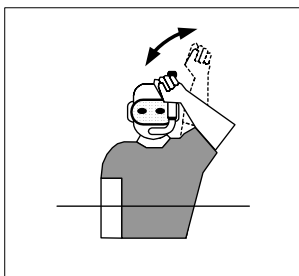



**APPENDIX "N"**

**SIGNALS**

**3.6.21 Breaking, False Start, or Encroachment**

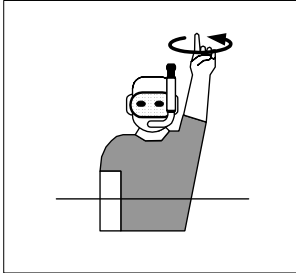

**3.6.22 Grabbing and/or Pulling on Wall Barriers**

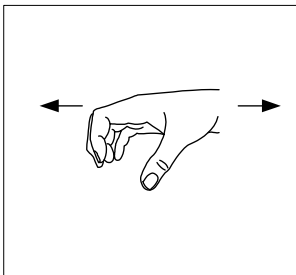

**3.6.23 Infringement Seen but the Advantage Rule is in Effect**

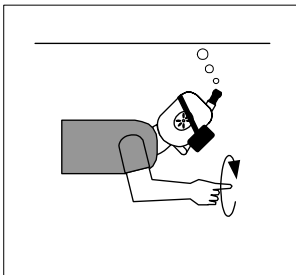

**3.6.24 Side-Line-Out or Puck Out-of-Bounds**

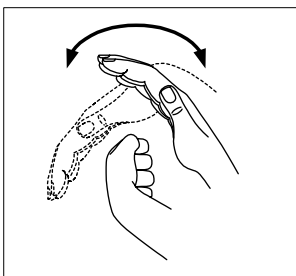



**APPENDIX "O" MULTILEVEL TOURNAMENT WITH EIGHT ENTRIES**

Seeding of Championship Bracket

Match L determines the World Champion and second place.

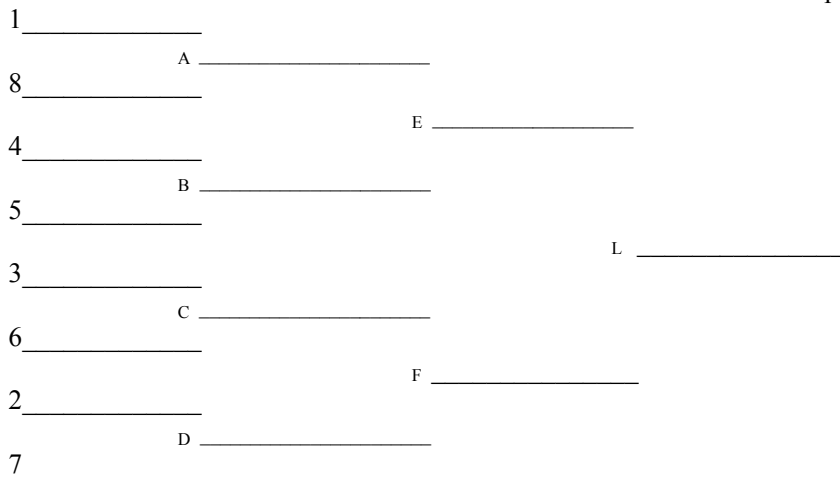

Match I determines third and fourth place.



Match K determines fifth and sixth place.

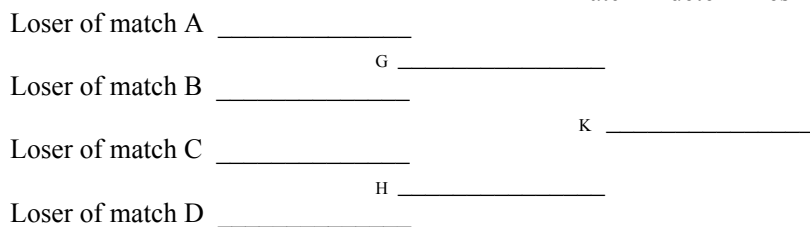

Match J determines seventh and eighth place.

